

Genuine



NEWSTAR™

JUNE 2009



**REPLACEMENT PARTS FOR
INTERNATIONAL TRUCKS**

DISCLAIMER

This International Truck Replacement Parts Catalog provides information on various replacement components offered by S&S Truck Parts, Inc. / NEWSTAR[®] Parts Component Group. We have extensively examined the material provided to assure accuracy and reliability. However, this information should only be used to assist the user in identifying the product we are offering as a replacement.

Trademark Acknowledgements

S & S Truck Parts, Inc. / NEWSTAR[®] Parts Component Group use of the names of original manufacturers, their models, types, part numbers and other descriptive product information is only for the purpose of aiding customers in cross-referencing to the appropriate S&S/ NEWSTAR[®] part. The following is a listing, compiled to the best of our knowledge, of Trademarks used in this catalog for the aforementioned purpose.

DANA is a trademark of DANA Corporation.

INTERNATIONAL TRUCK is a trademark of Navistar International Corp.

TABLE OF CONTENTS

FEATURED PRODUCTS	2
RADIATORS	
FILTERS	
STARTERS	
ALTERNATORS	
FRONT AXLE/SUSPENSION	3-8
BRAKE	9-14
STEERING	15-19
EXHAUST	20
ELECTRICAL	21-27
CAB AND BODIES	28-30
CLUTCH	31-33
ENGINE	34-40
MISCELLANEOUS HARDWARE	41-42
DRIVELINE	43-45
COMPLETE PARTS LISTING	46-54

FEATURED PRODUCTS

RADIATORS



NEWSTAR NUMBER	REPLACEMENT FOR INTERNATIONAL NUMBER
S-D629	493349C3
S-D630	493359C4
S-D631	493367C4
S-D629	1668900C92
S-17264	1668901C92
S-16536	1697273C2
S-16538	2000985C93
S-16535	2502718C1
S-16537	2505159C91
S-16534	2585978C93

O.E.M. APPROVED - MADE IN THE USA

FILTERS



NEWSTAR NUMBER	REPLACEMENT FOR INTERNATIONAL NUMBER
SSAF1968M	AF1968M
SSAF25139M	AF25139M
SSLF689	LF689
SSFF5052	FF5052
SSFF5207	FF5207
SSFS1000	FS1000
SSFS1212	FS1212
SSLF3620	LF3620
SSLF3970	LF3970
SSLFP19000	LF9000
SSWF2071	WF2071
SSWF2072	WF2072
SSWF2074	WF2074
SSWF2077	WF2077

O.E.M. APPROVED - MADE IN THE USA

ALTERNATORS / STARTERS

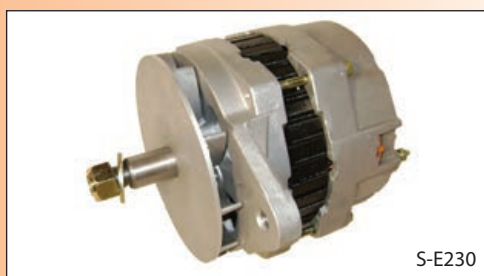

NEWSTAR NUMBER	REPLACEMENT FOR DELCO NUMBER	APPLICATION
S-E230	19020302	22SI 145 AMP 12 VOLT 5/16 B+ TERM
S-E231	19020305	22SI 100 AMP 12 VOLT 1/4 B+ TERM
S-E232	19020306	22SI 145 AMP 12 VOLT 1/4 B+ TERM
S-15369	19020388	22SI 130 AMP 12 VOLT QUAD MOUNT

NEW, NO CORE CHARGE



NEWSTAR NUMBER	REPLACEMENT FOR DELCO NUMBER	APPLICATION
S-E225	1990379	42MT 12 VOLT 12 T PINION
S-E227	1990456	42MT 24 VOLT 11 T PINION
S-E226	1990483	42MT 12 VOLT 11 T PINION

NEW, NO CORE CHARGE

FRONT AXLE / SUSPENSION

SHOCK ABSORBERS

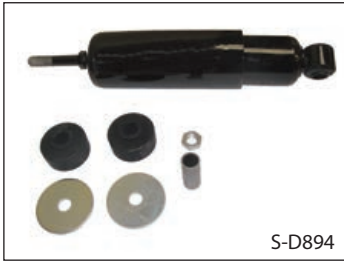

S-D894



S-5421



S-11797

NEWSTAR NUMBER	REPLACEMENT FOR INTERNATIONAL NUMBER	SERIES	APPLICATION
S-5421	503610C2	9300,9400	W/10,800 TO 14600 LB. SUSPENSION
S-D894	1664788C2 2015556C1 2032533C1	4900,8000,9000	W/14M LB. SUSPENSION
S-11797	3514952C91		
S-5421	AMS6886 AMS600103	9300,9400	W/10,800 TO 14600 LB. SUSPENSION

TORQUE ROD

ASSEMBLIES



S-E913



S-E914

NEWSTAR NUMBER	REPLACEMENT FOR INTERNATIONAL NUMBER	LENGTH
S-E913	493920C3	CENTER TO CENTER 18 1/8"
S-14653	501565C2	CENTER TO CENTER 25 1/4"
S-E914	2504006C91	CENTER TO CENTER 22"
S-14653	3580088C91	CENTER TO CENTER 25 1/4"
S-E913	3581271C1	CENTER TO CENTER 18 1/8"

SHACKLES



NEWSTAR NUMBER	REPLACEMENT FOR INTERNATIONAL NUMBER	OAL	TRUCK / SERIES
S-4523	301701C1	5 1/2"	FLEETSTAR
S-3137	346130C1	—	DAYTON 4-SPRING
S-3959	468699C1	5 1/2"	S-SERIES
S-5247	503959C1	6 11/16"	9370, 9670
S-8732	546036C1	6 1/2"	9370, 9670
S-8733	1654269C1	5 3/4"	8000

LATEST ADDITIONS TO OUR CATALOG

UNLESS OTHERWISE NOTED, ALL PARTS SUPPLIED ARE S & S/NEWSTAR. USE OF OTHER MANUFACTURERS' NAMES, PART NUMBERS, OR TRADEMARKS ARE FOR INFORMATIONAL AND IDENTIFICATION PURPOSES ONLY.



FRONT AXLE / SUSPENSION

SPRING PINS



S-5779

NEWSTAR NUMBER	REPLACEMENT FOR INTERNATIONAL NUMBER	LENGTH	TYPE
S-5017	76771R1	4 5/8"	REAR SHACKLE
S-3598	99530HB	4 7/8"	UPPER SHACKLE
S-5102	193989R1	5 7/16"	FRONT BRACKET
S-2409	206258R3	5 1/2"	MAIN REBOUND
S-2680	303859C1	5 5/16"	FRONT BRACKET
S-2357	303865C1	6 3/16"	FRONT & REAR
S-4882	443864C2	7 1/8"	FRONT BRACKET
S-5087	468703C2	7"	FRONT BRACKET
S-5779	507203C1	7 3/8"	FRONT BRACKET
S-2634	688952R1	7 3/8"	FRONT & REAR
S-5087	1648109C1	7"	FRONT BRACKET
S-5088	1648110C1	6 5/16"	REAR SHACKLE
S-7580	1661976C3	7"	FRONT BRACKET
S-7579	1671766C1	5 35/64"	REAR BRACKET
S-7580	3511254C1	7"	FRONT BRACKET

U-BOLTS



S-A414

NEWSTAR NUMBER	REPLACEMENT FOR INTERNATIONAL NUMBER	SIZE	LENGTH
S-3072	465916C1	3/4" NF	10"
S-4983	581742C1	3/4" NF	13.5"
S-A414	1514626C1	7/8" NF	12.4"

BUSHINGS



S-3938



S-D892



S-3888



S-5601



S-3778

NEWSTAR NUMBER	REPLACEMENT FOR INTERNATIONAL NUMBER	SERIES
S-3888	322069C91	TORQUE ROD BUSHING FOR CARGOSTAR TRUCKS W/ HENDRICKSON SUSPENSIONS
S-D892	497501C2	EQUALIZER BUSHING 4000, 8000 SERIES TRUCKS
S-3938	503579C1	BUSHING, REAR MOUNT 8000 SERIES TRUCKS
S-5601	688951R1	SPRING PIN BUSHING USED W/ 507203C1, 688952R1
S-3778	987395R3	CAB HINGE BUSHING CARGOSTAR, TRANSTAR

FRONT AXLE / SUSPENSION

BUSHINGS



S-8728



S-7572



S-A829

NEWSTAR NUMBER	REPLACEMENT FOR INTERNATIONAL NUMBER	DESCRIPTION	SERIES
S-8728	503359C1	BUSHING, CAP PIVOT	9370, 9670
S-7572	503611C1	BUSHING AND PIN ASSEMBLY WITH RUBBER BUSHING	9370, 9670
S-A829	507569C91	BUSHING, CAP PIVOT ENGINE MOUNT W/CAST RETAINER	8000, 9370, 9670

INSULATORS



S-2121



S-D905



S-D906



S-3780

NEWSTAR NUMBER	REPLACEMENT FOR INTERNATIONAL NUMBER	DESCRIPTION	SERIES
S-3780	200106R1	ENGINE MOUNT	9370, 9670
S-2888	286324C2	ENGINE MOUNT USED W/ DT466 & CAT 3208 ENGINES	PAYSTAR
S-2121	969783R1	MOTOR MOUNT	CARGOSTAR
S-D905	1664723C3	FRONT ENGINE MOUNT	4000 & 8000
S-D906	1664726C2	FRONT & REAR ENGINE MOUNT	4000 & 8000

LATEST ADDITIONS TO OUR CATALOG

UNLESS OTHERWISE NOTED, ALL PARTS SUPPLIED ARE S & S/NEWSTAR. USE OF OTHER MANUFACTURERS' NAMES, PART NUMBERS, OR TRADEMARKS ARE FOR INFORMATIONAL AND IDENTIFICATION PURPOSES ONLY..

FRONT AXLE / SUSPENSION

INSULATORS



S-2595



S-2729



S-11575



S-3777

NEWSTAR NUMBER	REPLACEMENT FOR INTERNATIONAL NUMBER	DESCRIPTION	SERIES
S-2595	80445R1	ENGINE MOUNT	4000 & 8000
S-2729	470031C2	MOTOR MOUNT USED W/ CAT 3406, CUMMINS NTC & DETROIT DIESEL 6V92 & 6L71 ENGINES	EARLY MODEL 1600 & 2200
S-11575	476869C1	MOTOR MOUNT USED W/ CAT 3306, 3406 DETROIT DIESEL 8V71, 8V92, 6V92, 8V71 & CUMMINS NTC ENGINES	EARLY MODEL 4000 & 5000
S-3777	583955C1 479237C1	MOTOR MOUNT USED W/ CAT 3406, 3408 DETROIT DIESEL 6V92, 8V92 ENGINES & CUMMINS L10, NTC ENGINES	9370 & 9670
S-3779	996160C1	SECONDARY INSULATOR	CARGOSTAR
S-2731	753997C93	MOTOR MOUNT USED W/ CAT 3306, 3406 DETROIT DIESEL 8V71, 8V92, 6V92, 8V71 & CUMMINS NTC ENGINES	EARLY MODEL 4000 & 5000

DRAW KEY



NEWSTAR NUMBER	REPLACEMENT FOR INTERNATIONAL NUMBER	DESCRIPTION
S-3199	441246C1	FRONT SPRING S-SERIES TRUCKS

FRONT AXLE / SUSPENSION

KING PIN KITS



S-9327

NEWSTAR NUMBER	REPLACEMENT FOR INTERNATIONAL NUMBER	AXLE MODEL	NEWSTAR NUMBER	REPLACEMENT FOR INTERNATIONAL NUMBER	AXLE MODEL
S-C464	ETN0328344	E1000I, 1200I			
S-C464	ETN0823078	E1000I, 1200I	S-6963	FAK4560	FF971
S-4996	FAK4446	FA65,80,89,91,97,98,99	S-6964	FAK4564	FF931,932,941
S-5014	FAK4450	FA12,20,28,30,40,41,48	S-6965	FAK4566	FG931,941,FF931,932,933,941,942
S-5015	FAK4451	FA60,68,69,70,72,48	S-8513	FAK4567	FG931
S-6493	FAK4461	4700,5000,5500 LB	S-8529	FAK4568	FL931,941,951
S-6494	FAK4471	6000,7000 LB	S-8678	FAK4570	FF961
S-5132	FAK4475	FA119	S-6946	FAK4571	FL901,FH901
S-6663	FAK4477	FA109	S-6485	FAK4572	EFA12F4
S-6499	FAK4478	3/4 TON-2WD	S-6486	FAK4573	EFA12F3 AND 13F3
S-6495	FAK4482	3/4-1 TON 2WD	S-9304	FAK4582	I60,80
S-7463	FAK4485	FA118,127,139,309,329,339,342,401	S-8371	FAK4583	EFA12F4
S-4948	FAK4496	FA118,127,329,139,339	S-A811	FAK4601	I1005,I1205
S-3596	FAK4497	FA109	S-D562	FAK4610	E1000I,1200I
S-4948	FAK4498	FA118,127,329,139,339,	S-5223	FAK5444	FA71,73,74,101,103,104
S-4949	FAK4500	FA309	S-4948	FAK5445	FA118,127,329,139,339
S-5134	FAK4516	FA309	S-4948	FAK5446	FA118,127,329,139,339
S-7801	FAK4517	FA401,139,118,127,309,329,339,342	S-4949	FAK5447	FA309
S-6939	FAK4527	FE910,910	S-4949	FAK5448	FA309
S-6938	FAK4531	FD900,901,903,208,209	S-5134	FAK5451	FA309
S-3492	FAK4532	6000,7000 LB	S-5223	FAK5452	FA71,73,74,101,103,104
S-6939	FAK4533	FE900,910	S-4988	FAK5453	FA118,127,139,309,329,342,401
S-6942	FAK4538	FE970	S-A483	FAK5455	I1005,I1205
S-6943	FAK4539	FE970	S-A484	FAK5456	I140S
S-6944	FAK4540	FD211,215,216,218	S-4756	FAK8492	(SHIM)
S-6945	FAK4541	FL901,FH901	S-13563	1668412C91	I140S
S-6946	FAK4542	FL901,FH901			
S-6947	FAK4544	FA211,215,216,218			
S-5132	FAK4547	FA119			
S-6938	FAK4548	FD900,901,902,903			
S-6943	FAK4550	FD208,209			
S-6947	FAK4551	FE970			
S-6950	FAK4553	FA211,215,216,218			
S-6948	FAK4555	FF921			
S-6949	FAK4558	FF931			
S-6950	FAK4559	FL931			
		FF921			

LATEST ADDITIONS TO OUR CATALOG

UNLESS OTHERWISE NOTED, ALL PARTS SUPPLIED ARE S & S/NEWSTAR. USE OF OTHER MANUFACTURERS' NAMES, PART NUMBERS, OR TRADEMARKS ARE FOR INFORMATIONAL AND IDENTIFICATION PURPOSES ONLY.



FRONT AXLE / SUSPENSION

DRAG LINKS



NEWSTAR NUMBER	REPLACEMENT FOR INTERNATIONAL NUMBER	AXLE SHAFTS	LENGTH
S-4707	FDL970A	FA98,101	14.75"
S-4603	FDL1034A	FA71,73,101,104	16.84"
S-A719	FDL1214A	S-SERIES,COF5870,8000	17.68"
S-C618	FDL1215A	I60S,I80S	14.47"

TIE ROD ENDS



NEWSTAR NUMBER	REPLACEMENT FOR INTERNATIONAL NUMBER	TYPE
S-5056	FTR187L	FD,FE,FG900
S-5057	FTR187R	FD,FE,FG900
S-4767	FTR373L	FA71,73,74,101,103,104
S-4768	FTR373R	FA71,73,74,101,103,104
S-7459	FTR411L	FA109,118,339,342,309,127,341,340,329,139,337
S-7460	FTR411R	FA109,118,339,342,309,127,341,340,329,139,337
S-7358	FTR423L	FF931,941,932,921,FA109,309,139,329,339
S-7357	FTR423R	FF931,941,932,921,FA109,309,139,329,339
S-5048	FTR431L	FH901,FL901
S-5049	FTR431R	FH901,FL901
S-8634	FTR2069R	FO90,120,D
S-8635	FTR2070L	FO90,120,D
S-6659	FTR2090L	FL931,941,FH901
S-5988	FTR2091R	FL931,941,FH901
S-6659	FTR3033L	FL931,941,FH901
S-5988	FTR3034R	FL931,941,FH901
S-E395	FTR3476	E10001,12001,13201
S-E394	FTR3477	E10001,12001,13201
S-A764	FTR8224	16,051,805
S-A765	FTR8225	16,051,805
S-D639	FTR8407	1405
S-D640	FTR8408	1405
S-B599	FTR8409	12,051,405
S-B600	FTR8410	12,051,405
S-12090	263498C91	FA68, 72, 89
S-12091	263499C91	FA68, 72, 89
S-F505	1658946C91	S-SERIES FOR DROPPED I-BEAM
S-F506	1658947C91	S-SERIES FOR DROPPED I-BEAM

BRAKE

BRAKE CALIPERS

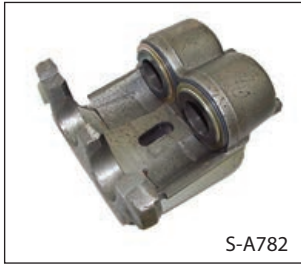

S-A782



S-A917



S-10131



S-10130

NEWSTAR NUMBER	REPLACEMENT FOR INTERNATIONAL NUMBER	DESCRIPTION	SERIES
S-A782	1658443C91	TWIN PISTON 2.88"	MEDIUM S-SERIES & 4000 SERIES
S-A917	1669311C91	TWIN PISTON 2.60"	MEDIUM S-SERIES & 4000 SERIES
S-10131	2501838C91	TWIN PISTON 73MM	4000 SERIES
S-10130	2501839C91	TWIN PISTON 66MM	4000 SERIES
S-10130	2509253C91	TWIN PISTON 66MM	4000 SERIES
S-10131	2509254C91	TWIN PISTON 73MM	4000 SERIES
S-A917	582024C91	TWIN PISTON 2.60"	MEDIUM S-SERIES & 4000 SERIES
S-A782	55250	TWIN PISTON 2.88"	MEDIUM S-SERIES & 4000 SERIES
S-A917	55314	TWIN PISTON 2.60"	MEDIUM S-SERIES & 4000 SERIES
S-10130	55849	TWIN PISTON 66MM	4000 SERIES
S-10131	55850	TWIN PISTON 73MM	4000 SERIES

BRAKE PADS

NEWSTAR NUMBER REPLACEMENT FOR INTERNATIONAL NUMBER

S-E738 990953C91
 USED WITH S-A782 (ABOVE)
 BRAKE CALIPER
 MEDIUM S-SERIES & 4000 SERIES TRUCK & BUSES



NEWSTAR NUMBER REPLACEMENT FOR INTERNATIONAL NUMBER

S-4252 582028C91
 USED WITH S-A917 (ABOVE)
 BRAKE CALIPER
 MEDIUM S-SERIES & 4000 SERIES TRUCK & BUSES



NEWSTAR NUMBER REPLACEMENT FOR INTERNATIONAL NUMBER

S-13998 2501841C91
 USED WITH S-10130 (ABOVE)
 BRAKE CALIPER
 4000 SERIES TRUCK & BUSES



NEWSTAR NUMBER REPLACEMENT FOR INTERNATIONAL NUMBER

S-13997 2501842C91
 USED WITH S-10131 (ABOVE)
 BRAKE CALIPER
 4000 SERIES TRUCK & BUSES



LATEST ADDITIONS TO OUR CATALOG

UNLESS OTHERWISE NOTED, ALL PARTS SUPPLIED ARE S & S/NEWSTAR. USE OF OTHER MANUFACTURERS' NAMES, PART NUMBERS, OR TRADEMARKS ARE FOR INFORMATIONAL AND IDENTIFICATION PURPOSES ONLY.

BRAKE

EMERGENCY BRAKE SHOES AND COMPONENTS



S-4641



S-3502



S-A173



S-9985

NEWSTAR NUMBER	REPLACEMENT FOR INTERNATIONAL NUMBER	DESCRIPTION
S-4641	178417R92 91888	9 1/2" X 2 1/2" BRAKE BAND MEDIUM DUTY S-SERIES W/ T495,698 TRANSMISSIONS
S-3502	232040R91 A3-3722-E-421	12" X 4" DCM S-SERIES, 4000 SERIES TRUCK & BUS
S-A173	388912C91 A2-3722-G-501	10" X 3" DCM S-SERIES, 4000 SERIES TRUCK & BUS
S-9985	583503C91 597577C92	9" X 3" DDM S-SERIES, 4000 SERIES TRUCK & BUS

EMERGENCY BRAKE SHOE SPRINGS SOLD IN PACKS OF 10 EACH



NEWSTAR NUMBER	REPLACEMENT FOR INTERNATIONAL NUMBER	
S-3145	233009R1	USED WITH S-3502 232040R91 BRAKE SHOES

STRUT



S-3886

NEWSTAR NUMBER	REPLACEMENT FOR INTERNATIONAL NUMBER	
S-3886 S-C120	233010R11 388914C1 (A-3787-Q-17) (A-3787-N-14)	USED WITH S-3502 232040R91 BRAKE SHOES

BACKING PLATES



NEWSTAR NUMBER	REPLACEMENT FOR INTERNATIONAL NUMBER	
S-9046	232049R11 (A-3736-K-375)	USED WITH S-3502 232040R91 BRAKE SHOES

BRAKE DUST SHIELD

NEWSTAR NUMBER	REPLACEMENT FOR INTERNATIONAL NUMBER
S-13954	590684C91



ABS BRAKE ROTORS

NEWSTAR NUMBER	REPLACEMENT FOR INTERNATIONAL NUMBER
S-11177	3531661C2 5 STUD

DAYTON WALTHER STYLE
15" MAJOR DIAMETER / OVERALL HEIGHT 3 1/2"
WITH ABS EXCITER TEETH
RUST INHIBITOR COATING
4000 SERIES TRUCKS & BUSES



NEWSTAR NUMBER	REPLACEMENT FOR INTERNATIONAL NUMBER
S-13295	3531663C2 10 STUD

DAYTON WALTHER STYLE
15" MAJOR DIAMETER / OVERALL HEIGHT 4 1/2"
WITH ABS EXCITER TEETH
RUST INHIBITOR COATING



NEWSTAR NUMBER	REPLACEMENT FOR INTERNATIONAL NUMBER
S-E743	3531662C1 10 STUD

DAYTON WALTHER STYLE
15" MAJOR DIAMETER / OVERALL HEIGHT 3.125"
WITH ABS EXCITER TEETH
RUST INHIBITOR COATING
4000 SERIES TRUCKS & BUSES



PEDAL PAD

NEWSTAR NUMBER	REPLACEMENT FOR INTERNATIONAL NUMBER
S-7565	166880R1

MEDIUM DUTY S-SERIES &
4000 SERIES TRUCKS



LATEST ADDITIONS TO OUR CATALOG

UNLESS OTHERWISE NOTED, ALL PARTS SUPPLIED ARE S & S/NEWSTAR. USE OF OTHER MANUFACTURERS' NAMES, PART NUMBERS, OR TRADEMARKS ARE FOR INFORMATIONAL AND IDENTIFICATION PURPOSES ONLY.

BRAKE

AIR DRYER ASSEMBLY



NEWSTAR NUMBER	REPLACEMENT FOR INTERNATIONAL NUMBER
----------------	--------------------------------------

S-F345	BX065225 BX109685
--------	----------------------

12 VOLT COMPLETE REPLACEMENT UNIT

AIR DRYER CARTRIDGE



NEWSTAR NUMBER	REPLACEMENT FOR INTERNATIONAL NUMBER
----------------	--------------------------------------

S-A474	BX107794 BX107796
--------	----------------------

INCLUDES SEAL RING KIT
NEW CARTRIDGE - SOLD OUTRITE
NO CORE CHARGES

TREADLE AND PLATE ASSY. 45

FITS ALL FOOT VALVES EXCEPT E-7



NEWSTAR NUMBER	REPLACEMENT FOR INTERNATIONAL NUMBER
----------------	--------------------------------------

S-11201	SN4017A BX275747
---------	---------------------

MEDIUM DUTY S-SERIES &
4000 SERIES TRUCKS

DASH CONTROL VALVE



NEWSTAR NUMBER	REPLACEMENT FOR INTERNATIONAL NUMBER
----------------	--------------------------------------

S-16988	BX065157
---------	----------

TYPE I PLATE (RECESSED) W/ .275" OPEN MOUNTING HOLES (4)

BRAKE

BRAKE VALVE

NEWSTAR NUMBER	REPLACEMENT FOR INTERNATIONAL NUMBER
----------------	--------------------------------------

S-4771	BX286171
--------	----------

3/8" NPT SUPPLY PORTS (4)
3/8" NPT DELIVERY PORTS (4)
DUAL CIRCUIT VALVE



AIR GOVERNOR

NEWSTAR NUMBER	REPLACEMENT FOR INTERNATIONAL NUMBER
----------------	--------------------------------------

S-6106	BX275491
--------	----------

ALL PORTS 1/8" NPT
INCLUDES 4 PLUGS, MOUNTING GASKET
GOVERNORS ARE PRE-SET @ 125 PSI



QUICK RELEASE VALVES

NEWSTAR NUMBER	REPLACEMENT FOR INTERNATIONAL NUMBER
----------------	--------------------------------------

S-4922	BX229859
S-4922	BX288251

3/8" NPT SUPPLY - 3/8" NPT DELIVERY

NEWSTAR NUMBER	REPLACEMENT FOR INTERNATIONAL NUMBER
----------------	--------------------------------------

S-8328	BX229860
--------	----------

1/2" NPT SUPPLY - 3/8" NPT DELIVERY



S-4922

NEWSTAR NUMBER	REPLACEMENT FOR INTERNATIONAL NUMBER
----------------	--------------------------------------

S-9749	BX289714
--------	----------

1/4" NPT SUPPLY
3/8" NPT DELIVERY (2)
1/4" NPT BALANCE



LATEST ADDITIONS TO OUR CATALOG

UNLESS OTHERWISE NOTED, ALL PARTS SUPPLIED ARE S & S/NEWSTAR. USE OF OTHER MANUFACTURERS' NAMES, PART NUMBERS, OR TRADEMARKS ARE FOR INFORMATIONAL AND IDENTIFICATION PURPOSES ONLY.

BRAKE

45" X 32.75" AIR SYSTEMS POSTERS AVAILABLE ON REQUEST

CHECK OUT OUR ENTIRE AIR BRAKE PROGRAM

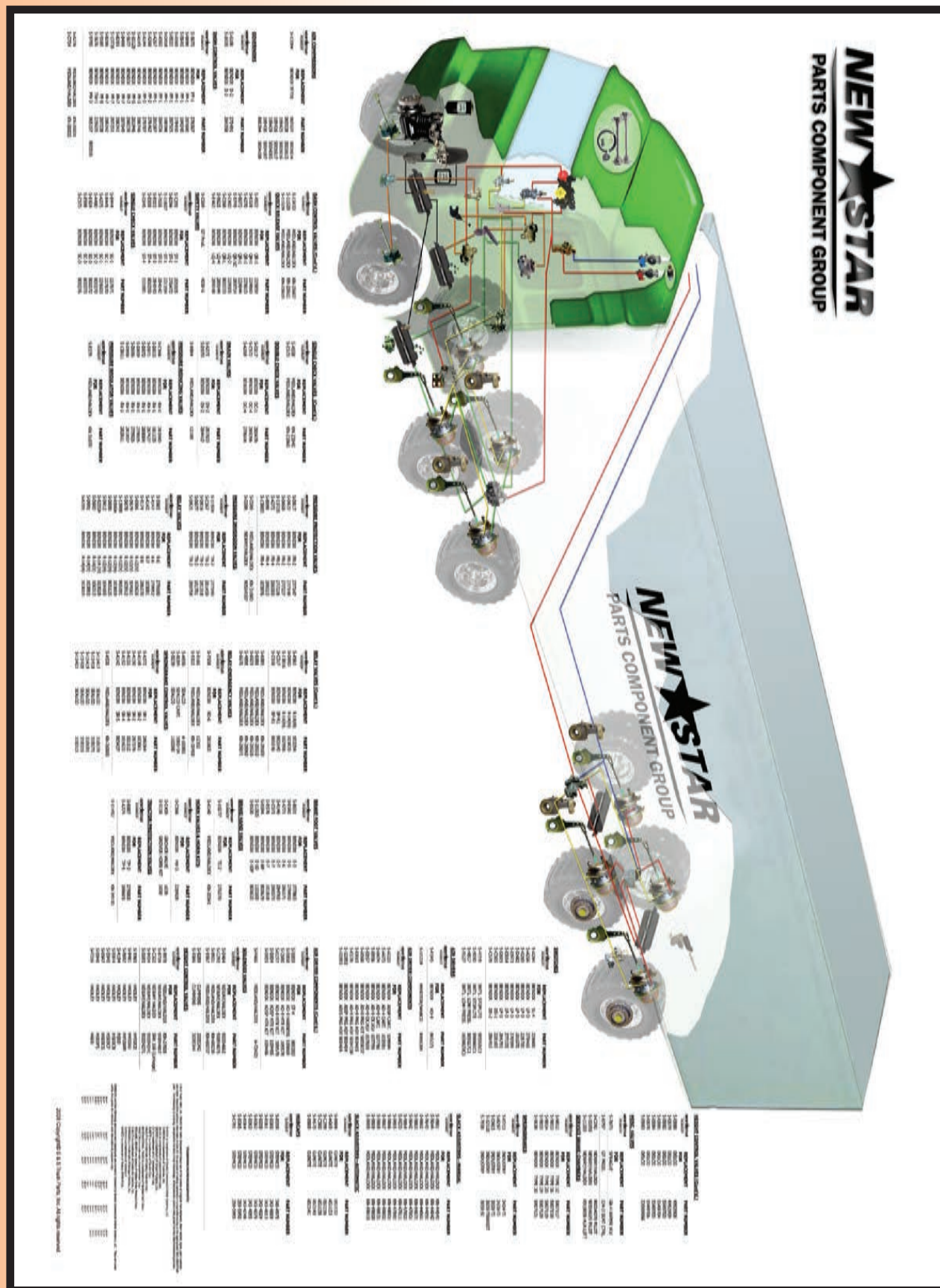

REPLACEMENT POWER STEERING PUMPS

VICKERS APPLICATION : MODEL V-10F

3 LINE PUMP
 FLOW CONTROL COVER
 2 BOLT FLANGE (SAE 'A' SIZE)
 1" NPT INLET PORT
 3/4" - 16 ST. THREAD PRESSURE PORT
 1/2" NPT TANK PORT

ALL R.H. ROTATION



S-B151

NEWSTAR NUMBER	REPLACEMENT FOR INTERNATIONAL NUMBER	SHAFT	CAPACITY	FLOW	PRESSURE
S-B149	785910C93	9 TOOTH	5	5	1750
S-B147	789423C91	KEYED	5	5	1750
S-B150	791242C91	9 TOOTH	7	5	1750
S-B148	792547C91	9 TOOTH	5	5	1250
S-B151	792548C91	9 TOOTH	7	5	1750

VICKERS APPLICATION : MODEL V-10NF

2 LINE PUMP
 FLOW CONTROL COVER
 2 BOLT FLANGE (SAE 'A' SIZE)
 15 / 16 " NPT INLET PORT
 3/4"- 16 NPT PRESSURE PORT

ALL R.H. ROTATION



S-B163

NEWSTAR NUMBER	REPLACEMENT FOR INTERNATIONAL NUMBER	SHAFT	CAPACITY	FLOW	PRESSURE
S-A711	582135C92	11 TOOTH	6	5	1750
S-B164	595055C91	11 TOOTH	5	5	2000
S-B163	1654771C91	11 TOOTH	5	4	2175
S-B164	1681049C91	11 TOOTH	5	5	2000

VICKERS APPLICATION : MODEL V-20F

3 LINE PUMP
 FLOW CONTROL COVER
 2 BOLT FLANGE (SAE 'A' SIZE)
 1 1/4 " NPT INLET PORT
 3/4"- 16 NPT PRESSURE PORT
 1/2" NPT TANK PORT

ALL R.H. ROTATION



S-B166

NEWSTAR NUMBER	REPLACEMENT FOR INTERNATIONAL NUMBER	SHAFT	CAPACITY	FLOW	PRESSURE
S-A525	422479C91	11 TOOTH	9	6	1750
S-B166	583808C91	11 TOOTH	6	6	1750

LATEST ADDITIONS TO OUR CATALOG

UNLESS OTHERWISE NOTED, ALL PARTS SUPPLIED ARE S & S/NEWSTAR. USE OF OTHER MANUFACTURERS' NAMES, PART NUMBERS, OR TRADEMARKS ARE FOR INFORMATIONAL AND IDENTIFICATION PURPOSES ONLY.

REPLACEMENT POWER STEERING PUMPS

VICKERS APPLICATION : MODEL V-20NF



2 LINE PUMP
FLOW CONTROL COVER
2 BOLT FLANGE (SAE 'A' SIZE)
1.3125" - 12 STR. THR. NPT INLET PORT
3/4" - NPT. THREAD PRESSURE PORT

NEWSTAR NUMBER	REPLACEMENT FOR INTERNATIONAL NUMBER	SHAFT	CAPACITY	FLOW	PRESSURE	
S-A526	541508C91	11 TOOTH	6	6	1750	R.H.
S-B210	541510C91	11 TOOTH	9	6	1750	L.H.
S-B208	585929C91	THREADED	9	6	1750	R.H.
S-B209	585930C91	11 TOOTH	9	6	1750	R.H.
S-B207	1615247C91	THREADED	6	6	1750	L.H.

LUK APPLICATION : VT73



2 LINE PUMP
ALUMINUM CONSTRUCTION
2 BOLT FLANGE

NEWSTAR NUMBER	REPLACEMENT FOR INTERNATIONAL NUMBER	SHAFT	FLOW	PRESSURE	
S-D484	1663204C91	11 TOOTH	4.00	2000	R.H.
S-5890	1681047C91	11 TOOTH	3.70	1740	R.H.
S-17041	1682625C91	11 TOOTH	3.75	2325	L.H.
S-17552	2005337C91	11 TOOTH	4.00	2175	R.H.
S-17665	2010412C92	W/GEAR DRIVE	4.00	2400	L.H.

SAGINAW APPLICATION : 143



FLOWRATE 3.85-4.25 GPM
PRESSURE SETTING 1450-1550 PSI

NEWSTAR NUMBER	REPLACEMENT FOR INTERNATIONAL NUMBER
S-5897	488787C91

COMPLETE PUMP WITH RESERVOIR
NEW OUTRIGHT, NO CORE CHARGE

NEWSTAR NUMBER	REPLACEMENT FOR INTERNATIONAL NUMBER	DESCRIPTION
S-8005	492358C1	OIL SEAL NEW STYLE
S-7990	594210C91	MASTER REBUILD KIT
S-8006	868137R92	OIL SEAL OLD STYLE

SAGINAW APPLICATION : DUAL PISTON METRIC 710



FITS INTERNATIONAL TRUCK
LATE MODEL S SERIES

NEWSTAR NUMBER	REPLACEMENT FOR INTERNATIONAL NUMBER
S-9497	1681130C93



LATEST ADDITIONS TO OUR CATALOG

UNLESS OTHERWISE NOTED, ALL PARTS SUPPLIED ARE S & S/NEWSTAR. USE OF OTHER MANUFACTURERS' NAMES, PART NUMBERS, OR TRADEMARKS ARE FOR INFORMATIONAL AND IDENTIFICATION PURPOSES ONLY. .

REPLACEMENT POWER STEERING PUMPS

HOBOURN APPLICATION : MODEL BB

NEW - OUTRIGHT NO CORE CHARGE

BASIC REPLACEMENT PUMP
11 TOOTH SPLINE SHAFT
FLOW RATE 5.5-6 GPM
PRESSURE SETTING 2000-2200 PSI

NEWSTAR NUMBER	REPLACEMENT FOR INTERNATIONAL NUMBER
S-B214	1667498C91 1669412C91

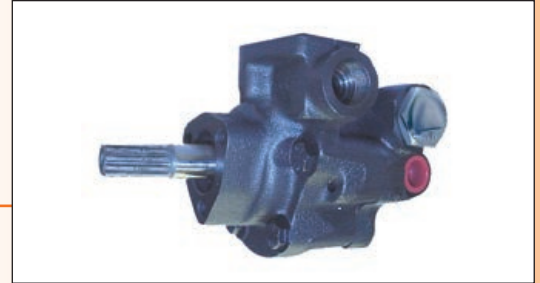

BASIC REPLACEMENT PUMP
BOLT & KEY PULLEY SHAFT DRIVEN
FLOW RATE 5.5-6 GPM
PRESSURE SETTING 2300 PSI

NEWSTAR NUMBER	REPLACEMENT FOR INTERNATIONAL NUMBER
S-B215	596246C92 1675898C91 1677288C91

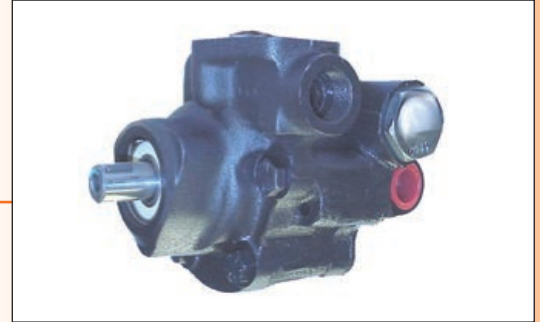

BASIC REPLACEMENT PUMP
BOLT & KEY PULLEY SHAFT
FLOW RATE 6 GPM
PRESSURE SETTING 2350 PSI
6.9 - 7.3 L DIESEL APPLICATIONS

NEWSTAR NUMBER	REPLACEMENT FOR INTERNATIONAL NUMBER
S-B216	1614025C91 1655606C91 1655607C91 1664376C91 1665551C91 1684290C91 1666272C91 1671589C91 1671876C91 1654717C91

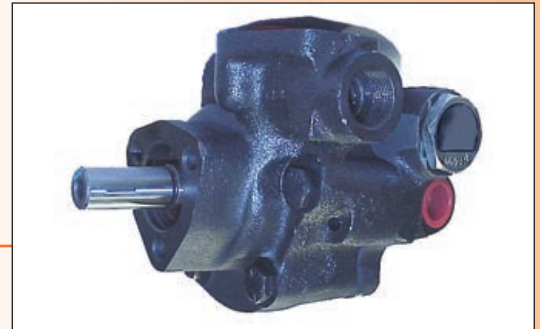

HOBOURN APPLICATION : MODEL B
NEW - OUTRIGHT NO CORE CHARGE

PULLER DRIVE
1750 PSI
LOW VOLUME
AXLE RATING 12000 LBS.

NEWSTAR NUMBER	REPLACEMENT FOR INTERNATIONAL NUMBER
S-4811	493115C91

MEDIUM & HEAVY DUTY
S SERIES TRUCKS



LATEST ADDITIONS TO OUR CATALOG

UNLESS OTHERWISE NOTED, ALL PARTS SUPPLIED ARE S & S/NEWSTAR. USE OF OTHER MANUFACTURERS' NAMES, PART NUMBERS, OR TRADEMARKS ARE FOR INFORMATIONAL AND IDENTIFICATION PURPOSES ONLY..

STEERING

SECTOR SHAFTS

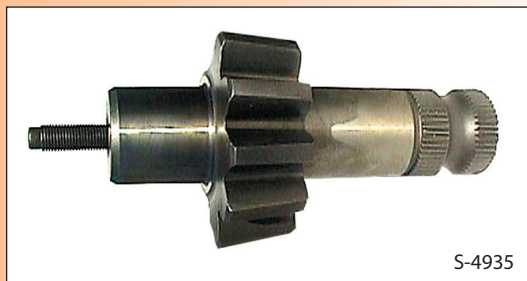

FITS INTERNATIONAL TRUCK
LATE MODEL S SERIES

NEWSTAR NUMBER	REPLACEMENT FOR INTERNATIONAL NUMBER	APPLICATION
S-E036	1663631C1	M100
S-E445	1668428C1	M90
S-7943	435854C91	HF64
S-4935	487344C91	HFB64, TAS65

INPUT (WORM) SHAFT



NEWSTAR NUMBER REPLACEMENT FOR INTERNATIONAL NUMBER

S-15180 **1668441C92**

APPLICATION: TAS65

REMOTE MOUNT RESERVOIR PARTS - RESERVOIR



NEWSTAR NUMBER REPLACEMENT FOR INTERNATIONAL NUMBER

S-D589 1686736C91

TO REPLACE INTERNATIONAL TRUCK HEAVY DUTY MODELS 2000/8000 & HEAVY DUTY MODELS 1000/4000

REMOTE MOUNT RESERVOIR PARTS - FILTER ELEMENT



NEWSTAR NUMBER REPLACEMENT FOR INTERNATIONAL NUMBER APPLICATION

S-D590 1691121C1 LATE MODEL S-SERIES
HF6162

REMOTE MOUNT RESERVOIR PARTS - OIL LEVEL GAUGE



NEWSTAR NUMBER REPLACEMENT FOR INTERNATIONAL NUMBER APPLICATION

S-D591 1691125C1

STEERING

REBUILDING KITS AND COMPONENTS

NEWSTAR NUMBER	REPLACEMENT FOR INTERNATIONAL NUMBER	APPLICATION	DESCRIPTION
S-4376 S-4912 S-4957 S-7979 S-8004	507809C91 467537C91 507810C91 505657C92 507811C1	HOBOURN SERIES B HOBOURN SERIES B HOBOURN SERIES B HOBOURN SERIES B HOBOURN SERIES B	RESERVOIR FILTER KIT RESERVOIR CAP ASSY. O-RING KIT MOUNTING KIT SEAL RING
S-7988	434031C91	VICKERS PUMP SERIES V10	MASTER KIT
S-7989	590727C91	VICKERS PUMP SERIES V20	MASTER KIT
S-4336 S-4950 S-7997	493141C91 493143C91 493133C91	SAGINAW DUAL PISTON 710 SAGINAW DUAL PISTON 710 SAGINAW DUAL PISTON 710	MASTER KIT PITMAN SHAFT KIT BEARING 2.003 O.D.
S-7995	482350C91	SAGINAW ROTARY VALVE	SECTOR SHAFT SEAL
S-D421	2502009C92	SHEPPARD M90	STEERING GEAR KIT
S-A392	1685195C91 1685196C91 2502008C91	SHEPPARD M100	STEERING GEAR KIT
S-5370	406280C1	SHEPPARD SERIES 3, 4, AND 5 2' ID X 2.375" OD MODELS 372, 392	BRONZE BUSHING
S-7942	438758C1	SHEPPARD SERIES 3, 4, AND 5 2' ID X 2.25" OD MODELS 292, 372, 392	BRONZE BUSHING
S-7983	1651917C91	SHEPPARD SERIES 6 MODEL 392	MASTER KIT
S-4591 S-4936 S-8018 S-8020A S-8022 S-8024 S-8025 S-8029	583823C91 487364C91 21015R1 487333C1 487340C1 487360C1 487361C1 487359C1	TRW HFB52 TRW HFB52 TRW HFB52 TRW HFB52 TRW HFB52 TRW HFB52 TRW HFB52 TRW HFB52	MASTER KIT SECTOR SHAFT RETAINING RING SEAL CUP HOUSING OUTER SEAL STEEL BACK UP WASHER HOUSING OUTER SEAL SUPPORT RING
S-4033 S-8000	472925C91 435673C1	TRW HF54 TRW HF54	MASTER KIT PISTON RING
S-4590 S-8021 S-8933	582463C91 487339C91 487320C91	TRW HFB64 TRW HFB64 TRW HFB64	MASTER KIT HOUSING SEAL THRUST BEARING
S-4412 S-8002 S-8933 S-7943	472933C91 474577C91 487320C91 435854C91	TRW HF64 TRW HF64 TRW HF64 TRW HF64	MASTER KIT PISTON RING THRUST BEARING SECTOR SHAFT
S-7198	1692999C91	TRW HF70	MASTER KIT
S-7627	1671216C93	TRW TAS-65	MASTER KIT
S-9501	1675137C91	TRW TAS40	REBUILD KIT (NO HARDWARE)
S-9502	1675138C91	TRW TAS55	REBUILD KIT (NO HARDWARE)
S-11558	2589611C91	SHEPPARD M80	STEERING GEAR KIT

LATEST ADDITIONS TO OUR CATALOG

UNLESS OTHERWISE NOTED, ALL PARTS SUPPLIED ARE S & S/NEWSTAR. USE OF OTHER MANUFACTURERS' NAMES, PART NUMBERS, OR TRADEMARKS ARE FOR INFORMATIONAL AND IDENTIFICATION PURPOSES ONLY.



EXHAUST

EXHAUST CLAMPS - PREFORMED JOINT CLAMPS



S-8476

NEWSTAR NUMBER	REPLACEMENT FOR INTERNATIONAL NUMBER	DESCRIPTION
S-B339	EC30PLS	3" PREFORMED CLAMP STAINLESS
S-C110	EC35PLA	3.5" PREFORMED CLAMP ALUMINIZED
S-8476	EC40PLA	4" PREFORMED CLAMP ALUMINIZED
S-D424	EC40PLS	4" PREFORMED CLAMP STAINLESS
S-C109	EC40PLB	4" BUTT CLAMP ALUMINIZED
S-7687	EC50PLA	5" PREFORMED CLAMP ALUMINIZED
S-A999	EC50PLS	5" PREFORMED CLAMP STAINLESS

EXHAUST CLAMPS - FLAT BAND JOINT CLAMPS



S-4966

NEWSTAR NUMBER	REPLACEMENT FOR INTERNATIONAL NUMBER	DESCRIPTION
S-B068	DCX004478	3" FLAT BAND CLAMP STAINLESS
S-C111	DCX006203	4" FLAT BAND CLAMP ALUMINIZED
S-4965	EC40EST	4" FLAT BAND CLAMP STAINLESS
S-4966	EC50EST	5" FLAT BAND CLAMP STAINLESS
S-4965	549558C91	4" FLAT BAND CLAMP STAINLESS
S-4966	549559C91	5" FLAT BAND CLAMP STAINLESS

EXHAUST CLAMPS - U-BOLT CLAMPS



S-4333

NEWSTAR NUMBER	REPLACEMENT FOR INTERNATIONAL NUMBER	SIZE
S-4332	554318C1	4"
S-4333	554319C1	5"
S-D967	XH4CC, XH89548K	4"
S-A862	XH89549K	5"

MUFFLER



NEWSTAR NUMBER	REPLACEMENT FOR INTERNATIONAL NUMBER
S-13490	2018471C1

ELECTRICAL

BLOWER MOTORS - 12 VOLT-CLOCKWISE FLANGE MOUNTED



NEWSTAR NUMBER	REPLACEMENT FOR INTERNATIONAL NUMBER	DESCRIPTION
S-8583	1669786C1	12 VOLT - CLOCKWISE FLANGE MOUNTED 4000 & 8000 SERIES
S-9660	1699291C1	12 VOLT - CLOCKWISE FLANGE MOUNTED 4000 & 8000 SERIES
S-F427	1676648C1	WITH HARNESS & HEAVY DUTY DESIGN 12 VOLT - COUNTERCLOCKWISE STUD MOUNTED - VENTED
S-F429	2503267C91	MULTI-PURPOSE SINGLE SHAFT BLOWER MOTOR 12 VOLT-STRAP MOUNT, VENTED, DOUBLE SHAFT, PM ROTATION BLOWER MOTOR
S-4923	474086C1	PAYSTAR MEDIUM & HEAVY DUTY SERIES TRUCKS
S-5174	421843C1	PAYSTAR, TRANSTAR TRUCKS

WINDSHIELD WIPER MOTOR

NEWSTAR NUMBER	REPLACEMENT FOR INTERNATIONAL NUMBER
S-10407	1661843C1 3539699C91 3528713C91

4000 & 8000 SERIES TRUCKS



WASHER FLUID TANK AND PUMP

NEWSTAR NUMBER	REPLACEMENT FOR INTERNATIONAL NUMBER	DESCRIPTION
S-4585	394120C91	TANK WITH PUMP
S-3852	404618C1	REPLACEMENT PUMP



NOZZLE

NEWSTAR NUMBER	REPLACEMENT FOR INTERNATIONAL NUMBER
S-14004	1696499C1



LATEST ADDITIONS TO OUR CATALOG

UNLESS OTHERWISE NOTED, ALL PARTS SUPPLIED ARE S & S/NEWSTAR. USE OF OTHER MANUFACTURERS' NAMES, PART NUMBERS, OR TRADEMARKS ARE FOR INFORMATIONAL AND IDENTIFICATION PURPOSES ONLY.

ELECTRICAL

HORNS AND RELATED PARTS - DUAL AIR HORN



NEWSTAR NUMBER	REPLACEMENT FOR INTERNATIONAL NUMBER
S-5116	244283R91
4000, 8000, 9370, 9670 SERIES TRUCKS MEDIUM & HEAVY DUTY S-SERIES TRUCKS	

HORNS AND RELATED PARTS - AIR HORN VALVE



NEWSTAR NUMBER	REPLACEMENT FOR INTERNATIONAL NUMBER
S-C459	682506R91
USED WITH S-5116 AIR HORN KIT	

HORNS AND RELATED PARTS - HORNS



S-4730

NEWSTAR NUMBER	REPLACEMENT FOR INTERNATIONAL NUMBER
S-4730 (HIGH)	411948C91, 165519R91
S-4731 (LOW)	411949C91, 166166R91
4000, 8000, 9370, 9670 SERIES TRUCKS MEDIUM & HEAVY DUTY S-SERIES TRUCKS	



S-17570

NEWSTAR NUMBER	REPLACEMENT FOR INTERNATIONAL NUMBER
S-17570 (LOW)	3523179C91
S-17571 (HIGH)	3523180C91



S-17571

4000, 8000, 9370, 9670 SERIES TRUCKS
MEDIUM & HEAVY DUTY S-SERIES TRUCKS

HORNS AND RELATED PARTS - HORN RELAYS



S-7606

S-9443

NEWSTAR NUMBER	REPLACEMENT FOR INTERNATIONAL NUMBER
S-7606	505457C1
S-9443	2012557C1
S-9443	3607384C1
9370, 9670 SERIES 4000, 7000, 8000 SERIES 4000, 7000, 8000 SERIES	

ELECTRICAL

HEADLIGHT SWITCHES AND DIMMERS

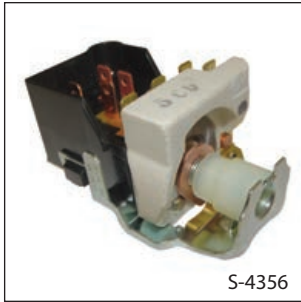

S-4356



S-13970



S-5970



S-15543

NEWSTAR NUMBER	REPLACEMENT FOR INTERNATIONAL NUMBER	DESCRIPTION	SERIES
S-4356	393442C1	DIMMER SWITCH	4000 SERIES & MEDIUM DUTY S-SERIES
S-13970	469859C1	KNOB	USED WITH S-4356 ABOVE
S-5970	577295C1	DIMMER SWITCH	9370, 9670 SERIES
S-15543	393442ASSY	SWITCH & KNOB ASSEMBLY	4000 SERIES & MEDIUM DUTY S-SERIES

2 SPEED SHIFT MOTORS AND COMPONENTS

FITS ALL LATE MODEL INTERNATIONAL TRUCKS



S-C634

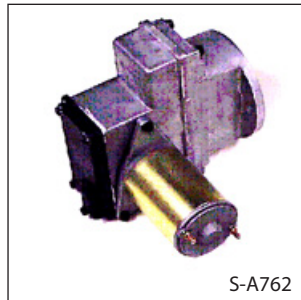

S-A762



S-8008



S-A760



S-8883



S-6058



S-5582

NEWSTAR NUMBER	REPLACEMENT FOR INTERNATIONAL NUMBER	DESCRIPTION
S-8883	ETN0040635 85374R91	2 SPEED SHIFT MOTOR
S-C634	ETN0113743	2 SPEED SHIFT MOTOR KIT
S-5691	ETN0113744	CIRCUIT BOARD ONLY
S-6058	ETN0113745	2 SPEED SHIFT MOTOR
S-A760	ETN0113753	HARNESS AND CONNECTOR
S-5318	ETN0119855	SEAL
S-A762	ETN0120750	2 SPEED SHIFT MOTOR ASSEMBLY
S-5582	ETN0122000	2 SPEED SHIFT KIT
S-8008	ETN0211319	CIRCUIT BOARD KIT

LATEST ADDITIONS TO OUR CATALOG

UNLESS OTHERWISE NOTED, ALL PARTS SUPPLIED ARE S & S/NEWSTAR. USE OF OTHER MANUFACTURERS' NAMES, PART NUMBERS, OR TRADEMARKS ARE FOR INFORMATIONAL AND IDENTIFICATION PURPOSES ONLY.

ELECTRICAL

TURN SIGNAL SWITCHES



NEWSTAR NUMBER	REPLACEMENT FOR INTERNATIONAL NUMBER	APPLICATION
S-4513	471302C91	MEDIUM DUTY S-SERIES TRUCKS & BUSES
S-9494	775863C93	MEDIUM & HEAVY DUTY S-SERIES NON-CANCELLING SWITCH
S-9729	1616317C91	4000 & 8000 SERIES TRUCKS
S-9494	1663595C91	MEDIUM & HEAVY DUTY S-SERIES NON-CANCELLING SWITCH
S-9724	1689991C91	1652 UPS MODEL

TURN SIGNAL SWITCHES - NEW IMPROVED DESIGNS



NEWSTAR NUMBER	REPLACEMENT FOR INTERNATIONAL NUMBER	APPLICATION
S-11182	3566936C91 2002875C91 TL963Y100	FOR VEHICLES USING NO WIPER CONTROL MEDIUM DUTY 4000 SERIES TRUCKS & BUSES
S-11183	3566941C91 2034257C91 TL962Y101	FOR VEHICLES USING NO WIPER CONTROL MEDIUM DUTY 4000 SERIES TRUCKS & BUSES

SOLENOID SWITCHES



NEWSTAR NUMBER	REPLACEMENT FOR INTERNATIONAL NUMBER	APPLICATION
S-D895	1115556 1618940C1	FOR 40, 50 MT
S-A649 S-E555	1693479C91 1115598	PRESTOLITE SYSTEMS FOR 42MT

ELECTRICAL

SWITCHES



S-4739

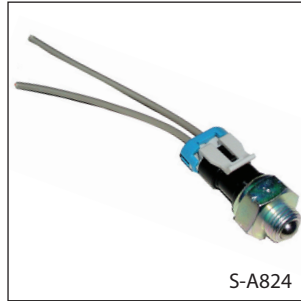

S-A824



S-9094

NEWSTAR NUMBER	REPLACEMENT FOR INTERNATIONAL NUMBER	DESCRIPTION
S-5115	241120R91	HORN RELAY
S-4664	295417C91	WINDSHIELD WASHER
S-3600	344688C91	IGNITION
S-4687	358560C1	STOP LIGHT
S-4739	416372C1	B-UP LIGHT
S-3600	429047C1	IGNITION
S-2523	434297C1	HEATER
S-2938	454925C1	B-UP LIGHT
S-3600	468438C91	IGNITION
S-2661	509190C2	TOGGLE
S-5018	777700C91	OIL SENDER
S-9104	1646970C1	B-UP LIGHT
S-9094	1661234C3	HEADLIGHT
S-4664	1694297C91	WINDSHIELD WASHER
S-A824	1699216C91	B-UP LIGHT

STOPLIGHT SWITCHES



S-4719

	NEWSTAR NUMBER	TYPE	REPLACEMENT FOR INTERNATIONAL NUMBER	
2 TERMINAL	S-4719	SEALED	505026C1	1/4"NTP
2 TERMINAL	S-9093	SEALED	598860C1	1/4"NTP
1 TERMINAL	S-5934	SEALED	642343C2	1/8"NTP
2 TERMINAL	S-4719	SEALED	873706R91	1/4"NTP
2 TERMINAL	S-A264	SL-4 STYLE	BX228600	1/4"NTP

LOW PRESSURE SWITCHES



S-A265

	NEWSTAR NUMBER	TYPE	REPLACEMENT FOR INTERNATIONAL NUMBER	
1 TERMINAL	S-4817	SEALED	505027C1	1/4"NTP
1 TERMINAL	S-9127	SEALED	1658820C1	1/8"NTP
2 TERMINAL	S-A265	LP3 STYLE	BX228750	1/4"NTP
1 TERMINAL	S-A266	LP3 STYLE	BX279416	1/4"NTP

LATEST ADDITIONS TO OUR CATALOG

UNLESS OTHERWISE NOTED, ALL PARTS SUPPLIED ARE S & S/NEWSTAR. USE OF OTHER MANUFACTURERS' NAMES, PART NUMBERS, OR TRADEMARKS ARE FOR INFORMATIONAL AND IDENTIFICATION PURPOSES ONLY.

ELECTRICAL

GAUGES

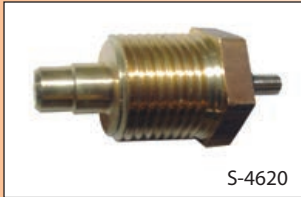

S-4620

NEWSTAR NUMBER	REPLACEMENT FOR INTERNATIONAL NUMBER	DESCRIPTION	SERIES
S-4620	479758C1	OIL SENDER GAUGE	MEDIUM & HEAVY DUTY S-SERIES TRUCKS

FUEL SENDER GAUGES



S-9438



S-9439



S-7601

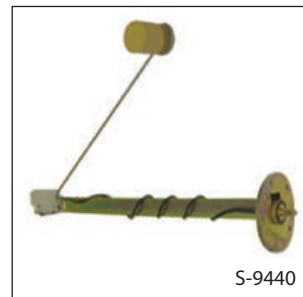

S-9440

NEWSTAR NUMBER	REPLACEMENT FOR INTERNATIONAL NUMBER	DESCRIPTION	SERIES
S-9438	476846C2	FUEL SENDER GAUGE	8000 SERIES TRUCKS & HEAVY DUTY S-SERIES
S-9439	497840C96	FUEL SENDER GAUGE	MEDIUM DUTY SERIES TRUCKS
S-7601	508999C2	FUEL SENDER GAUGE	9370, 9670 SERIES TRUCKS
S-9440	1684364C7	FUEL SENDER GAUGE	8000 SERIES

DISTRIBUTOR CAP



NEWSTAR NUMBER REPLACEMENT FOR INTERNATIONAL NUMBER

S-2214 877313R92

ENGINE MODEL V345, 392

ELECTRICAL

LAMPS AND HEADLIGHTS



NEWSTAR NUMBER	REPLACEMENT FOR INTERNATIONAL NUMBER	DESCRIPTION	SERIES
S-4883	444659C91 444660C91	STOP LIGHT	MEDIUM & HEAVY DUTY S-SERIES TRUCKS
S-4782	465458C91	HEAD LIGHT	MEDIUM & HEAVY DUTY S-SERIES TRUCKS
S-14067	1661281C91	LAMP	4000 & 8000 SERIES TRUCKS
S-9166	1661282C91	LAMP	4000 & 8000 SERIES TRUCKS
S-A644	1686721C91	HEAD LIGHT	4000 & 8000 SERIES TRUCKS

MISCELLANEOUS ELECTRICAL



NEWSTAR NUMBER	REPLACEMENT FOR INTERNATIONAL NUMBER	DESCRIPTION
S-2935	143240R91	OIL PRESSURE SENDER
S-5126	277055C91	BRAKE
S-5129	287116C91	CHOKE & THROTTLE CONTROL
S-4690	361974C1	ESCUTCHEON
S-5157	386025C1	ELECTRICAL CONTACT
S-4751	433178C1	BREAKER - 30 AMP
S-5971	447186C1	TURN SIGNAL
S-4797	476245C1	SIGNAL FLASHER
S-4945	493068C1	IGNITION CONDENSOR
S-A604	1688312C1	WARNING BUZZER
S-2935	1513678C92	OIL PRESSURE SENDER
S-9348	1652306C91	IGNITION SWITCH, KEYED - 4000 & 8000 SERIES
S-9437	1661383C1	BREAKER - 30 AMP
S-9442	1681254C1	BRAKE BOOSTER
S-C379	1688314C1	CONTROL MODULE
S-C380	2026910C1	HORN & B-UP ALARM
S-9620	2040568C91	INDICATOR LIGHT- 4000 & 8000 SERIES

LATEST ADDITIONS TO OUR CATALOG

UNLESS OTHERWISE NOTED, ALL PARTS SUPPLIED ARE S & S/NEWSTAR. USE OF OTHER MANUFACTURERS' NAMES, PART NUMBERS, OR TRADEMARKS ARE FOR INFORMATIONAL AND IDENTIFICATION PURPOSES ONLY.

CAB AND BODIES

HOOD HOLD DOWN KITS AND COMPONENTS - HOOD CATCH KITS



NEWSTAR NUMBER	REPLACEMENT FOR INTERNATIONAL NUMBER	
S-A287	1699929C91 500269A	MEDIUM & HEAVY DUTY S-SERIES 4000 & 8000 SERIES TRUCKS

INDIVIDUAL COMPONENTS

NEWSTAR NUMBER	REPLACEMENT FOR INTERNATIONAL NUMBER	DESCRIPTION
S-8043	499523C3	RUBBER STRAP
S-3136	500269C1	HANDLE
S-5588	500270C1	RETAINER
S-5589	500271C1	CATCH
S-9041	500273C1	PIN
S-A514	500274C1	CLIP



NEWSTAR NUMBER	REPLACEMENT FOR INTERNATIONAL NUMBER	
S-3061	491668C92	9370, 9670, 4000 & 8000 SERIES

HOOD HOLD DOWN KITS AND COMPONENTS - HOOD LATCH



NEWSTAR NUMBER	REPLACEMENT FOR INTERNATIONAL NUMBER
S-11605	3558776C1
	4000 & 8000 SERIES TRUCKS

HOOD HOLD DOWN KITS AND COMPONENTS - STEEL HOOD CATCH



NEWSTAR NUMBER	REPLACEMENT FOR INTERNATIONAL NUMBER
S-4654	266389C91
	CARGOSTAR BUSES & FLEETSTAR TRUCKS

CAB AND BODIES

DOOR AND WINDOW ACCESSORIES - DOOR HANDLE



S-E627



S-7630



S-7631



S-13951



S-3200



S-8530



S-9409

NEWSTAR NUMBER	REPLACEMENT FOR INTERNATIONAL NUMBER	DESCRIPTION	SERIES
S-9409	449766C93	WINDOW REGULATOR (LEFT SIDE)	MEDIUM DUTY S-SERIES & 4000 SERIES
S-9410	449767C93	WINDOW REGULATOR (RIGHT SIDE)	MEDIUM DUTY S-SERIES & 4000 SERIES
S-3200	475196C1	WINDOW HANDLE (CHROME PLATED)	PAYSTAR, S-SERIES, 9670, 9370 CONV, TRANSTAR,COF5870
S-13951	477257C94	DOOR LATCH	1000 & 4000
S-13952	477258C94	DOOR LATCH	1000 & 4000
S-7630	498003C2	DOOR LATCH (LEFT SIDE)	9370 & 9670
S-7631	498004C2	DOOR LATCH (RIGHT SIDE)	9370 & 9670
S-8530	1649776C1	WINDOW HANDLE (DARK PLATED)	PAYSTAR, S-SERIES, 9670, 9370 CONV, TRANSTAR,COF5870
S-E627	1680789C91	DOOR HANDLE	4000 & 8000
S-9409	1686704C91	WINDOW REGULATOR (LEFT SIDE)	MEDIUM DUTY S-SERIES & 4000 SERIES
S-9410	1686705C91	WINDOW REGULATOR (RIGHT SIDE)	MEDIUM DUTY S-SERIES & 4000 SERIES
S-E627	3550925C91	DOOR HANDLE	4000 & 8000
S-E627	3550930C91	DOOR HANDLE	4000 & 8000
S-E627	3550931C91	DOOR HANDLE	4000 & 8000

LATEST ADDITIONS TO OUR CATALOG

UNLESS OTHERWISE NOTED, ALL PARTS SUPPLIED ARE S & S/NEWSTAR. USE OF OTHER MANUFACTURERS' NAMES, PART NUMBERS, OR TRADEMARKS ARE FOR INFORMATIONAL AND IDENTIFICATION PURPOSES ONLY..

CAB AND BODIES

MISC. CAB AND BODY PARTS - FUEL CAP



NEWSTAR NUMBER	REPLACEMENT FOR INTERNATIONAL NUMBER
----------------	--------------------------------------

S-A968	576746C91
--------	-----------

4000 SERIES TRUCKS



NEWSTAR NUMBER	REPLACEMENT FOR INTERNATIONAL NUMBER
----------------	--------------------------------------

S-17348	2040848C1
---------	-----------

NON-LOCKING
ALUMINUM
2000-8000 SERIES TRUCKS

MISC. CAB AND BODY PARTS - SHIFT BOOT



NEWSTAR NUMBER	REPLACEMENT FOR INTERNATIONAL NUMBER
----------------	--------------------------------------

S-3204	286655C4
--------	----------

MEDIUM DUTY S-SERIES & 4000 SERIES TRUCKS

MISC. CAB AND BODY PARTS - HOOD BUMPER AND GUIDE



NEWSTAR NUMBER	REPLACEMENT FOR INTERNATIONAL NUMBER
----------------	--------------------------------------

S-2983	472697C1
S-4921	472698C1

MEDIUM DUTY S-SERIES & 4000 SERIES TRUCKS

CLUTCH FLYWHEELS

NEWSTAR NUMBER	REPLACEMENT FOR INTERNATIONAL NUMBER	ENGINE MODEL
S-2023	151115R31	V345,392
S-A856	1809144C91	6.9 LITER
S-A608	1810855C93	DT466B,C
S-10006	1818214C91	7.3L/T444E
S-10005	1821915C93	DT466E



CLUTCH RELATED COMPONENTS FOR 14" AND 15" CLUTCH ASSEMBLIES

NEWSTAR NUMBER	REPLACEMENT FOR INTERNATIONAL NUMBER	
S-9208	572107C91	BEARING AND SLEEVE ASSEMBLY



NEWSTAR NUMBER	REPLACEMENT FOR INTERNATIONAL NUMBER	
S-B039	797700C91	2" TORQUE LIMITING CLUTCH BRAKE REPLACEMENT FOR TTC PART NO 127760
S-B038	69883R1	1 3/4" TORQUE LIMITING CLUTCH BRAKE REPLACEMENT FOR TTC PART NO 127740



S-B039

NEWSTAR NUMBER	REPLACEMENT FOR INTERNATIONAL NUMBER	
S-7440	697924R6	CLUTCH RELEASE FORK



NEWSTAR NUMBER	REPLACEMENT FOR INTERNATIONAL NUMBER	
S-7660	697956R2	DRIVE PIN



CLUTCH CABLES

NEWSTAR NUMBER	REPLACEMENT FOR INTERNATIONAL NUMBER	
S-5275	315446C92	PAYSTAR, S-SERIES
S-5953	503701C91	9370, 9670

LATEST ADDITIONS TO OUR CATALOG

UNLESS OTHERWISE NOTED, ALL PARTS SUPPLIED ARE S & S/NEWSTAR. USE OF OTHER MANUFACTURERS' NAMES, PART NUMBERS, OR TRADEMARKS ARE FOR INFORMATIONAL AND IDENTIFICATION PURPOSES ONLY.

CLUTCH

NEW CLUTCH ASSEMBLIES



THE MOST COMPLETE LINE OF NEW CLUTCHES FOR CLASS 6, 7, AND 8 TRUCKS AVAILABLE IN THE AFTERMARKET.

MATCHED UNIT CONFIGURATIONS TO FIT YOUR NEEDS UP TO THE HIGHEST TORQUE RATED ENGINES. ALL MAKES COVERAGE FOR NORTH AMERICAN PRODUCED CLASS 6-7-8 VEHICLES.

1 YEAR, 100,000 MILE WARRANTY.

MADE IN THE USA.

NEWSTAR NUMBER	REPLACEMENT FOR INTERNATIONAL NUMBER	COVER ASSEMBLY NUMBER	ADJUSTMENT TYPE	BEARING TYPE	PLATE LOAD POUNDS	TORQUE RATING (ft/lbs)	CARRIER STYLE	FRICITION MATERIAL	CERAMIC CONFIG	NM OF SPRINGS	CONVENTIONAL	FREE TRAVEL	MIN. FLYWHEEL OPENING
14" X 1 3/4" CAST IRON TWO PLATE													
S-8308	C107035-22	C127400-1	MANUAL	GREASABLE	3200	800	ROUND	CERAMIC		R			7"
S-8307	C107035-36	C127400-1	MANUAL	GREASABLE	3200	600	ROUND	ORGANIC		R			7"
S-8310	C107035-53	C127400-1	MANUAL	GREASABLE	3200	1000	ROUND	CERAMIC	VTL	8	X		7"
S-8309	C107035-54	C127400-1	MANUAL	GREASABLE	3200	900	ROUND	ORGANIC		8	X		7"
S-E352	C107063-59	C127400-1	MANUAL	GREASABLE	3200	1150	4-PADDLE	CERAMIC	VSR	8	X		7"
14" X 2" CAST IRON TWO PLATE													
S-8304	C107034-19	C127390-1	MANUAL	GREASABLE	3200	800	ROUND	CERAMIC	VTL	R			7"
S-8303	C107034-30	C127390-1	MANUAL	GREASABLE	3200	600	ROUND	ORGANIC		R			7"
S-8305	C107034-32	C127390-1	MANUAL	GREASABLE	3200	1000	ROUND	ORGANIC		8	X		7"
S-8306	C107034-53	C127390-1	MANUAL	GREASABLE	3200	1000	ROUND	CERAMIC	VTL	8	X		7"
S-8305	C107034-54B	C127390-1	MANUAL	GREASABLE	3200	1000	ROUND	ORGANIC		8	X		7"
S-E353	C107050-59	C127390-1	MANUAL	GREASABLE	3200	1400	4-PADDLE	CERAMIC	VSR	8		X	7"
S-E354	C107950-59	C127390-4-M	MANUAL	GREASABLE	3200	1400	4-PADDLE	CERAMIC	VSR	8		X	7"
15 1/2" X 1 3/4" CAST IRON TWO PLATE													
S-8311	C107090-22	C127476-1	MANUAL	GREASABLE	3200	1000	ROUND	ORGANIC		R			7"
S-8314	C107090-52	C127476-1	MANUAL	GREASABLE	3200	1250	ROUND	CERAMIC	VTL	8	X		7"
S-8313	C107090-56	C127476-1	MANUAL	GREASABLE	3200	1100	ROUND	ORGANIC		8	X		7"
15 1/2" X 2" CAST IRON TWO PLATE													
S-8316	C107091-3	C127597-1	MANUAL	GREASABLE	3200	1100	ROUND	CERAMIC	VTL	R			7"
S-8315	C107091-27	C127597-1	MANUAL	GREASABLE	3200	1000	ROUND	ORGANIC		R			7"
S-8318	C107091-52	C127597-1	MANUAL	GREASABLE	3600	1150	ROUND	CERAMIC	VTL	8	X		7"
S-8317	C107091-59B	C127597-4	MANUAL	GREASABLE	3600	1250	ROUND	ORGANIC		8		X	7"
S-E355	C107091-77	C127597-4	MANUAL	GREASABLE	3600	1250	ROUND	ORGANIC		8		X	7"
S-E603	C107091-81	---	MANUAL	GREASABLE	3600	1400	4-PADDLE	CERAMIC	VSR	8		X	7"
S-E606	C107391-74	---	EASE-A-JUST	GREASABLE	3600	1650	4-PADDLE	CERAMIC	VSR	10	X		8.5"
S-E416	C107391-93	C127597-6	MANUAL	GREASABLE	4000	1850	6-PADDLE	CERAMIC	VSR	10	X		8.5"
S-E419	C107935-51	C150698-4-M	MANUAL	GREASABLE	3600	1650	4-PADDLE	CERAMIC	VSR	9	X		10"
S-E420	C107935-82	C150699-4-M	EASE-A-JUST	GREASABLE	3600	1700	4-PADDLE	CERAMIC	VSR	7		X	10"

CLUTCH

NEW CLUTCH ASSEMBLIES

NEWSTAR NUMBER	REPLACEMENT FOR INTERNATIONAL NUMBER	COVER ASSEMBLY NUMBER	ADJUSTMENT TYPE	BEARING TYPE	PLATE LOAD POUNDS	TORQUE RATING (ft/lbs)	CARRIER STYLE	FRICTION MATERIAL	CERAMIC CONFIG	NM OF SPRINGS	CONVENTIONAL	FREE TRAVEL	MIN. FLYWHEEL OPENING
14" DLB X 1 1/2" & 1 3/4"													
S-E425	LP1047-134	LP14-1047	EXTERNAL	GREASABLE	3200	500	ROUND	ORGANIC		10	X		7"
S-E426	LP1067-144	LP14-1067	EXTERNAL	GREASABLE	2800	550	ROUND	ORGANIC		10	X		7"
S-E427	LP1072-134	LP14-1072	EXTERNAL	GREASABLE	2000	550	ROUND	ORGANIC		10	X		7"
14" X 1 1/2" STAMPED STEEL SINGLE PLATE													
S-8295	C107688-7	C129710-3	EASE-A-JUST	GREASABLE	2400	520	4-PADDLE	CERAMIC	VSR	8	X		7"
14" X 1 3/4" STAMPED STEEL SINGLE PLATE													
S-8297	C107113-5	C127747-2	MANUAL	GREASABLE	2800	650	4-PADDLE	CERAMIC	VSR	8	X		7"
S-8296	C107113-7	C127747-2	MANUAL	GREASABLE	2800	445	ROUND	CERAMIC	VSR	8	X		7"
S-E432	C107683-5	C127747-1	MANUAL	GREASABLE	3200	650	3-PADDLE	CERAMIC	VTL	8	X		7"
S-E434	C107683-5	C129044-1	EASE-A-JUST	GREASABLE	3200	650	3-PADDLE	CERAMIC	VTL	8	X		7"
S-E433	C107683-16	C127747-1	MANUAL	GREASABLE	3200	445	ROUND	ORGANIC		8	X		7"
14" X 1 3/4" STAMPED STEEL TWO PLATE													
S-8299	C107137-5	C129044-2	MANUAL	GREASABLE	2800	900	3-PADDLE	CERAMIC	VSR	8	X		7"
S-8298	C107137-6	C129044-2	MANUAL	GREASABLE	2800	800	ROUND	ORGANIC		8	X		7"
S-E430	C107137-8	C129044-5	MANUAL	GREASABLE	2000	900	3-PADDLE	CERAMIC	VTL	8		X	7"
S-C580	C107237-8	C129060-5	EASE-A-JUST	GREASABLE	2000	900	3-PADDLE	CERAMIC	VTL	8		X	7"
S-E599	C107237-16	C129060-2	EASE-A-JUST	GREASABLE	2800	800	ROUND	ORGANIC		8	X		7"
14" X 2" STAMPED STEEL TWO PLATE													
S-8302	C107142-2	C129055-2	MANUAL	GREASABLE	2800	900	3-PADDLE	CERAMIC	VSR	8	X		7"
S-8301	C107142-3	C129055-2	MANUAL	GREASABLE	2800	800	ROUND	ORGANIC		8	X		7"
S-E600	C107342-11	C129061-5	EASE-A-JUST	GREASABLE	2000	900	3-PADDLE	CERAMIC	VTL	8		X	7"
14" X 1 3/4" SOFT PEDAL													
S-E437	C108063-59	C160051-1	MANUAL	GREASABLE	3200	1150	4-PADDLE	CERAMIC	VSR	8	X		7"
14" X 2" SOFT PEDAL													
S-E438	C108034-32	C160051-1	MANUAL	GREASABLE	3200	1000	ROUND	ORGANIC		8	X		7"
S-D574	C108050-59	C160051-1	MANUAL	GREASABLE	3200	1400	4-PADDLE	CERAMIC	VSR	8		X	7"
S-E439	C108950-59	C160051-1-M	MANUAL	GREASABLE	3200	1400	4-PADDLE	CERAMIC	VSR	8		X	7"
15 1/2" X 2" SOFT PEDAL													
S-C310	C108391-74B	C152705-4	MANUAL	GREASABLE	3600	1650	4-PADDLE	CERAMIC	VSR	10	X		8.5"
S-C308	C108391-78B	C152705-6	MANUAL	GREASABLE	4000	1400	ROUND	ORGANIC		10	X		8.5"
S-C309	C108391-81B	C152705-4	MANUAL	GREASABLE	3600	1450	4-PADDLE	CERAMIC	VSR	8		X	7"
S-E440	C108391-82	C152705-6	MANUAL	GREASABLE	4000	1350	ROUND	ORGANIC		8		X	7"
S-E441	C108391-93B	C152705-6	MANUAL	GREASABLE	4000	1850	6-PADDLE	CERAMIC	VSR	10	X		8.5"
S-C311	C108925-82B	C151455-4	MANUAL	GREASABLE	3600	1700	4-PADDLE	CERAMIC	VSR	7		X	10"
S-E442	C108935-51	C151455-4-M	MANUAL	GREASABLE	3600	1650	4-PADDLE	CERAMIC	VSR	9	X		10"
S-C697	C108935-91	C151455-4-M	MANUAL	GREASABLE	3600	1700	6-PADDLE	CERAMIC	VSR	9	X		10"
S-E443	C108935-94	C151455-6-M	MANUAL	GREASABLE	4000	1850	6-PADDLE	CERAMIC	VSR	9	X		10"

LATEST ADDITIONS TO OUR CATALOG

UNLESS OTHERWISE NOTED, ALL PARTS SUPPLIED ARE S & S/NEWSTAR. USE OF OTHER MANUFACTURERS' NAMES, PART NUMBERS, OR TRADEMARKS ARE FOR INFORMATIONAL AND IDENTIFICATION PURPOSES ONLY.



ENGINE

FAN CLUTCHES



NEWSTAR NUMBER	REPLACEMENT FOR INTERNATIONAL NUMBER	
S-14677	2509380C91	KYSOR K22RA

FAN CLUTCH REBUILDING KIT



NEWSTAR NUMBER	REPLACEMENT FOR INTERNATIONAL NUMBER	
S-14513	ZBH994205	KYSOR K22RA
S-14030	ZBH994305	
S-14676	ZBH994307	

FAN BELT



NEWSTAR NUMBER	REPLACEMENT FOR INTERNATIONAL NUMBER	
S-7664	311175C91, L17446	44.60"
S-9731	2012260C1	63.50"
S-9077	L17701	70.10"

MISCELLANEOUS CABLES



NEWSTAR NUMBER	REPLACEMENT FOR INTERNATIONAL NUMBER	DESCRIPTION	TRUCK MODEL
S-4754	439100C1	ACCELERATOR CABLE	S-SERIES
S-4773	453694C3	ACCELERATOR CABLE	S-SERIES
S-6034	475173C4	ACCELERATOR CABLE	S-SERIES
S-C396	475174C5	ACCELERATOR CABLE	S-SERIES
S-6034	475177C3	ACCELERATOR CABLE	S-SERIES
S-4799	477854C91	ACCELERATOR CABLE	LOADSTAR, FLEETSTAR
S-8327	488499C2	ACCELERATOR CABLE	MEDIUM DUTY S-SERIES
S-4117	549841C91	BATTERY CABLE	UNIVERSAL
S-9454	1651404C91	ACCELERATOR CABLE	8000 SERIES
S-9767	1694952C91	MODULATOR CABLE	4000 & 8000 SERIES
S-A638	2010529C91	ACCELERATOR CABLE	4000 SERIES

ENGINE

CAMSHAFT

NEWSTAR NUMBER	REPLACEMENT FOR INTERNATIONAL NUMBER
S-4443	1802338C91 DT466B, C ENGINES 1802339C92 1802506C91



OIL FILLER CAP

NEWSTAR NUMBER	REPLACEMENT FOR INTERNATIONAL NUMBER
S-4673	336079R91 CARGOSTAR, 9670 & S-SERIES TRUCKS



OIL CAP

NEWSTAR NUMBER	REPLACEMENT FOR INTERNATIONAL NUMBER
S-5328	379318C1 MU404, 446 ENGINES



THERMOSTATS

NEWSTAR NUMBER	REPLACEMENT FOR INTERNATIONAL NUMBER
S-6007	1807974C94

TEMP SETTING 192°
6.9 LITER ENGINES



ENGINE

DIPSTICKS



NEWSTAR NUMBER	REPLACEMENT FOR INTERNATIONAL NUMBER	SERIES
S-3302	151728R21	V345, 392 ENGINES
S-5331	691796C1	DT466B, C REAR SUMP
S-9168	1809497C1	6.9 LITER ENGINES
S-5331	1820953C4	DT466B, C REAR SUMP

FILTER ELEMENT



NEWSTAR NUMBER	REPLACEMENT FOR INTERNATIONAL NUMBER	
S-7670	498144C1	HEATER & AIR CONDITIONER 9370, 9670 SERIES TRUCKS

FUEL PUMP



NEWSTAR NUMBER	REPLACEMENT FOR INTERNATIONAL NUMBER	
S-7542	1804495C93	6.9 & 7.3 LITER ENGINES

CYLINDER HEAD BOLTS



NEWSTAR NUMBER	REPLACEMENT FOR INTERNATIONAL NUMBER	
S-4628	151363R1	V345, 392 (SHORT) - 6.9 & 7.3 LITER ENGINES
S-4519	151364R1	V345, 392 (LONG) - 6.9 & 7.3 LITER ENGINES
S-5966	1804027C2	6.9 LITER
S-8185	1809058C2	7.3 LITER

ENGINE

TURBO CLAMPS



NEWSTAR NUMBER	REPLACEMENT FOR INTERNATIONAL NUMBER	DESCRIPTION
S-9414	1674053C1	TURBO CLAMP
S-5222	1672105C91 3586939C1	5" TURBO CLAMP
S-4675	ZCP2500016 338614C1	3 1/2" TURBO CLAMP
S-7537	ZFS89533K	4" TURBO CLAMP

GLOW PLUGS

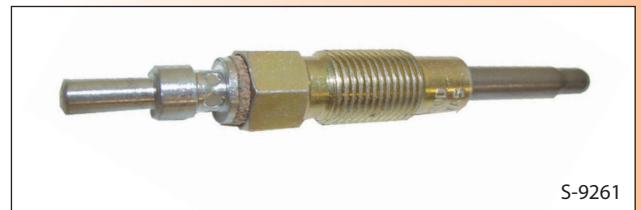

NEWSTAR NUMBER	REPLACEMENT FOR INTERNATIONAL NUMBER	DESCRIPTION
S-9715	1804211C2	6.9 LITER ENGINES
S-9261	1807917C1 1819649C1	7.3 LITER ENGINES
S-17172	1820697C1	T444E ENGINES

HEAD GASKET SETS

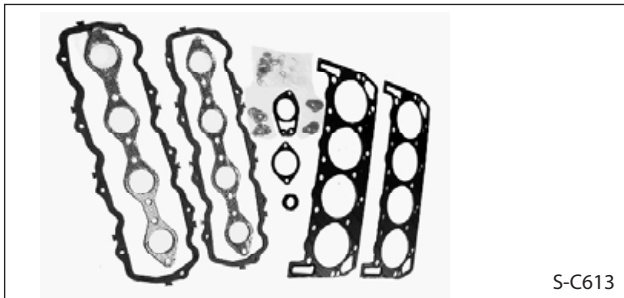

NEWSTAR NUMBER	REPLACEMENT FOR INTERNATIONAL NUMBER	DESCRIPTION
S-C613	1811049C91	6.9 LITER ENGINES
S-C614	1811050C91	7.3 LITER ENGINES

LATEST ADDITIONS TO OUR CATALOG

UNLESS OTHERWISE NOTED, ALL PARTS SUPPLIED ARE S & S/NEWSTAR. USE OF OTHER MANUFACTURERS' NAMES, PART NUMBERS, OR TRADEMARKS ARE FOR INFORMATIONAL AND IDENTIFICATION PURPOSES ONLY.

ENGINE

INTAKE VALVE PAN WITH GASKET

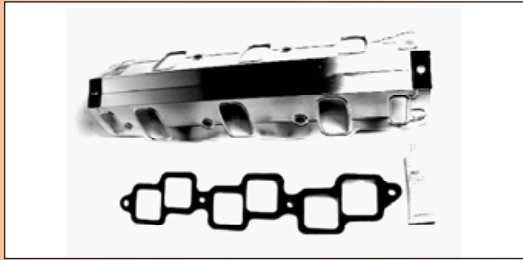

NEWSTAR NUMBER	REPLACEMENT FOR INTERNATIONAL NUMBER
----------------	--------------------------------------

S-C615	1813067C93
--------	------------

6.9 LITER ENGINES

OVERHAUL SETS



NEWSTAR NUMBER	REPLACEMENT FOR INTERNATIONAL NUMBER
----------------	--------------------------------------

S-5272	1808973C91 674398C96
--------	-------------------------

DT466B, C ENGINES
UPPER HEAD SET

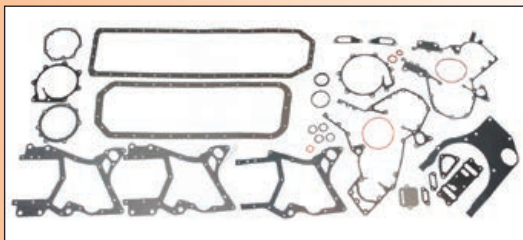

NEWSTAR NUMBER	REPLACEMENT FOR INTERNATIONAL NUMBER
----------------	--------------------------------------

S-5211	674399C95
--------	-----------

DT466B, C ENGINES
LOWER OIL PAN SET

RADIATORS



NEWSTAR NUMBER	REPLACEMENT FOR INTERNATIONAL NUMBER
----------------	--------------------------------------

S-D629	493349C3
S-D630	493359C4
S-D631	493367C4
S-D629	1668900C92
S-17264	1668901C92
S-16536	1697273C2
S-16538	2000985C93
S-16535	2502718C1
S-16537	2505159C91
S-16534	2585978C93

RADIATOR CAP

4000 & MEDIUM DUTY S-SERIES TRUCKS, DT360 ENGINES W/ AUTOMATIC TRANSMISSIONS



NEWSTAR NUMBER	REPLACEMENT FOR INTERNATIONAL NUMBER	PRESSURE RATING
----------------	--------------------------------------	-----------------

S-7625	130704R1	10LBS
S-6031	506017C1	10LBS
S-7625	530874R1	10LBS
S-6031	2504714C1	10LBS

S-6031 USED W/ RADIATOR SURGE TANKS

NO LONGER AVAILABLE FROM INTERNATIONAL TRUCK

NEWSTAR NUMBER	REPLACEMENT FOR INTERNATIONAL NUMBER
----------------	--------------------------------------

S-4986	586531C3
--------	----------

1600, 1700, 1800, 1900 AND 2100
MEDIUM SERIES MODELS EXCEPT BUS



NEWSTAR NUMBER	REPLACEMENT FOR INTERNATIONAL NUMBER
----------------	--------------------------------------

S-7890	1661919C5
--------	-----------

FITS LATE MODEL S-SERIES

NO DRAIN PORT



NEWSTAR NUMBER	REPLACEMENT FOR INTERNATIONAL NUMBER
----------------	--------------------------------------

S-8997	1619114C5
--------	-----------

FITS LATE MODEL S-SERIES

DRAIN PORT IN BACK



NEWSTAR NUMBER	REPLACEMENT FOR INTERNATIONAL NUMBER
----------------	--------------------------------------

S-15315	2505649C91
---------	------------

9700 AND 9800 SERIES



RADIATOR SURGE TANK SIGHT GLASS

NEWSTAR NUMBER	REPLACEMENT FOR INTERNATIONAL NUMBER
----------------	--------------------------------------

S-E849	1677713C1
--------	-----------

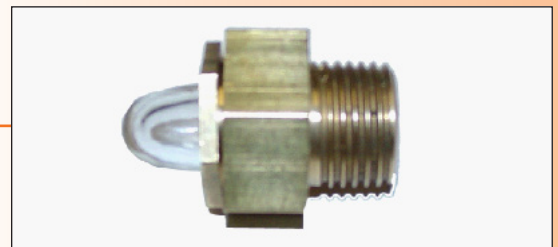

ENGINE

WATER PUMPS



NEWSTAR NUMBER	REPLACEMENT FOR INTERNATIONAL NUMBER
----------------	--------------------------------------

S-E803	1815538C91 WP181366
--------	------------------------

FITS ENGINE DT466C HEAVY DUTY
NEW - NO CORE CHARGE

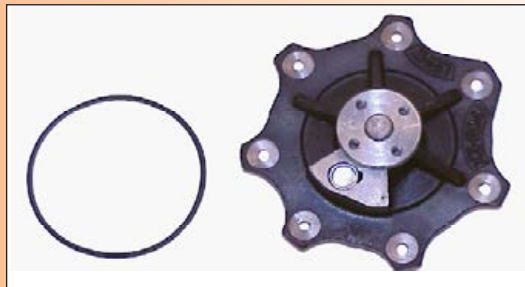

NEWSTAR NUMBER	REPLACEMENT FOR INTERNATIONAL NUMBER
----------------	--------------------------------------

S-B473	1817687C96 1830606C93
--------	--------------------------

FITS ENGINE DT466C MEDIUM DUTY
NEW - NO CORE CHARGE



NEWSTAR NUMBER	REPLACEMENT FOR INTERNATIONAL NUMBER
----------------	--------------------------------------

S-4293	685155C94 735327C91 WP181091
--------	------------------------------------

FITS ENGINE DT466A, B
NEW - NO CORE CHARGE



NEWSTAR NUMBER	REPLACEMENT FOR INTERNATIONAL NUMBER
----------------	--------------------------------------

S-13248	1831676C92
---------	------------

T444E ENGINES
NEW - NO CORE CHARGE



NEWSTAR NUMBER	REPLACEMENT FOR INTERNATIONAL NUMBER
----------------	--------------------------------------

S-D893	3803605
--------	---------

FITS ENGINE N14
NEW - NO CORE CHARGE

MISCELLANEOUS HARDWARE

FRAME BOLTS

NEWSTAR NUMBER	REPLACEMENT FOR INTERNATIONAL NUMBER	ENGINE MODEL
S-4433	414051C1	1/2"-20 X 1 1/4"
S-4434	414052C1	1/2"-20 X 1 1/2"
S-4435	414053C1	1/2"-20 X 1 3/4"
S-4436	414054C1	1/2"-20 X 2"
S-4437	414055C1	1/2"-20 X 2 1/4"
S-4438	414056C1	1/2"-20 X 2 1/2"
S-4505	414076C1	5/8"-18 X 1 1/2"
S-4733	414077C1	5/8"-18 X 1 3/4"
S-4734	414078C1	5/8"-18 X 2"
S-4735	414079C1	5/8"-18 X 2 1/4"
S-4736	414080C1	5/8"-18 X 2 1/2"
S-5861	414081C1	5/8"-18 X 2 3/4"
S-5862	414082C1	5/8"-18 X 3"
S-4442	414084C1	5/8"-18 X 3 1/2"
S-C635	416734C1	3/4"-16 X 2"
S-7604	416736C2	3/4"-16 X 2 1/2"
S-14718	416739C1	3/4"-16 X 3 1/4"
S-4440	424058C1	1/2"-20 X 3"
S-8420	438286C1	5/8"-18 X 4 1/2"



WHEEL LOCKS



NEWSTAR NUMBER	REPLACEMENT FOR INTERNATIONAL NUMBER	DESCRIPTION
S-7600	36416HB	2.531" I.D.
S-4792	470421C1	2.094" I.D.
S-4793	470422C1	2.66" I.D.
S-5898	581694C1	3.275" I.D.

MAGNETIC PLUG

NEWSTAR NUMBER	REPLACEMENT FOR INTERNATIONAL NUMBER
S-5753	586049C1
SIZE 3/4"-14 NPT	



LATEST ADDITIONS TO OUR CATALOG

UNLESS OTHERWISE NOTED, ALL PARTS SUPPLIED ARE S & S/NEWSTAR. USE OF OTHER MANUFACTURERS' NAMES, PART NUMBERS, OR TRADEMARKS ARE FOR INFORMATIONAL AND IDENTIFICATION PURPOSES ONLY.

MISCELLANEOUS HARDWARE

NUTS



NEWSTAR NUMBER	REPLACEMENT FOR INTERNATIONAL NUMBER	TYPE
S-5070	144425H	NYLON-SUSPENSION
S-4155	19499R1	NYLON-TRANSMISSION
S-5105	21814H	ALL METAL-WHEEL
S-4651	25893R1	ALL METAL-WHEEL
S-4155	26244R1	NYLON-AXLE
S-2245	41419V	ALL METAL-WHEEL
S-2889	41420V	ALL METAL-WHEEL
S-4955	50325R1	ALL METAL-WHEEL
S-4961	54495R2	ALL METAL-WHEEL
S-7665	83155H	ALL METAL-WHEEL
S-7666	83156H	ALL METAL-WHEEL
S-7622	144424H	NYLON-SUSPENSION
S-4700	388355C1	ALL METAL-AXLE
S-4737	414087C1	ALL METAL-SUSPENSION
S-4738	414089C1	ALL METAL-SUSPENSION
S-4740	416743C1	ALL METAL-SUSPENSION
S-5848	421913C1	CASTELLATED-AXLE
S-3929	440302C1	ALL METAL-AXLE
S-C106	591219C1	NYLON-TRANSMISSION
S-4740	1675448C1	ALL METAL-SUSPENSION
S-9720	1696471C1	NYLON-AXLE
S-A796	1696472C1	NYLON-AXLE
S-3929	1696474C1	NYLON-AXLE
S-7622	2003027C1	NYLON-AXLE
S-4740	2502028C1	ALL METAL-SUSPENSION
S-9195	BX239357	ALL METAL-AIR
S-5848	ETNOO83799	CASTELLATED-AXLE
S-6603	FUL22254	NYLON-TRANSMISSION

WHEEL NUT



NEWSTAR NUMBER	REPLACEMENT FOR INTERNATIONAL NUMBER
S-9415	1649492C1

DRIVELINE

CENTER BEARINGS



NEWSTAR NUMBER	----- REPLACEMENT FOR -----		SERIES
	INTERNATIONAL NUMBER	DANA® NUMBER	
S-7935	1662709C91 283067C93	210084-2X	1550,1610,1650
S-7934	1662710C91 1676270C91 386418C91	210088-1X	1280,1310
S-D457	383182C91	210090-1X	1280,1310,1330,1350,1410
S-1980	ZKC2101211X 1662711C91 1676271C91 283069C93 291870C91	210121-1X	1710
S-D458	1662712C91	210130-1X	1550,1610
S-D460	1662713C91	210140-1X	1350,1410,1480
S-C448	466505C91	210207-1X	1550,1610,1650
S-D459	1662722C91	210367-1X	1280,1310,1330,1350,1410
S-D461	_____	210370-1X	1280,1310,1330,1350,1410
S-7020	ZKC2103911X 1676273C91 315442C91 484002C91	210391-1X	1310,1410,1480
S-E319	_____	210433-1X	1410,1480
S-7926	ZKC2106611X 1662725C91 1676305C91 283071C93	210661-1X	1760,1810
S-B240	_____	210866-1X	1310 THRU 1550
S-B333	1669550C91	210875-1X	1760,1810
S-E020	_____	210881-1X	1710

STRAP and U-BOLT KITS

NEWSTAR NUMBER	REPLACEMENT FOR INTERNATIONAL NM	REPLACEMENT FOR DANA® NUMBER	DESCRIPTION	SERIES
S-D689	_____	2-8-59	STRAP KIT	1710, 1760, 1810
S-B608	1662835C91	2-70-18X	STRAP KIT	1310, 1330
S-B609	1662836C91	2-70-28X	STRAP KIT	1310, 1330
S-B610	_____	2-94-28X	U-BOLT KIT	1310, 1330
S-15366	_____	2-94-58X	U-BOLT KIT	1330F
S-B612	1662883C91	3-70-28X	STRAP KIT	1350, 1410
S-B613	1658833C91	3-70-38X	STRAP KIT	1480, 1550
S-B614	_____	3-94-18X	U-BOLT KIT	1350, 1410
S-B615	_____	3-94-28X	U-BOLT KIT	1480, 1550
S-A955	1658834C91	5-70-28X	STRAP KIT	1610
S-A293	1658835C91	6.5-70-18X	STRAP KIT	1710, 1760, 1810
S-D756	1658128C91	90-70-28X	STRAP KIT	FOR SPL90X®
S-D757	2500674C91	170-70-28X	STRAP KIT	FOR SPL170X®
S-D758	2500675C91	250-70-28X	STRAP KIT	FOR SPL250X®
S-E715	2507286C91	212214X	STRAP KIT	1710



LATEST ADDITIONS TO OUR CATALOG

SPL__X® is a registered trademark of DANA Corporation

UNLESS OTHERWISE NOTED, ALL PARTS SUPPLIED ARE S & S/NEWSTAR. USE OF OTHER MANUFACTURERS' NAMES, PART NUMBERS, OR TRADEMARKS ARE FOR INFORMATIONAL AND IDENTIFICATION PURPOSES ONLY.

DRIVELINE

UNIVERSAL JOINTS

DUAL ZERK FITTING
FOR SUPERIOR GREASE
PENETRATION

1 YEAR UNLIMITED
MILE WARRANTY

ISO9000 CERTIFIED

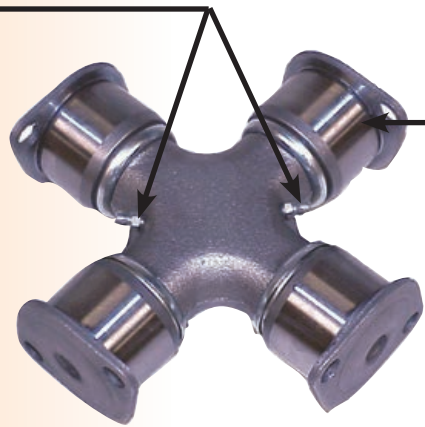

STEEL SEAL DESIGN
FOR IMPROVED
GREASE RETENTION AND
LONGER LIFE

NEWSTAR NUMBER	----- REPLACEMENT FOR -----			NEWSTAR NUMBER	----- REPLACEMENT FOR -----		
	INTERNATIONAL NUMBER	DANA® NUMBER	SERIES		INTERNATIONAL NUMBER	DANA® NUMBER	SERIES
S-9671	_____	5-103X	1000	S-13841	_____	5-5031X	5CBL
S-7021	_____	5-115X	1500	S-7032	_____	5-510X	1810 1/2 ROUND
S-9684	_____	5-1204X	55	S-7033	_____	5-515X	1710 1/2 ROUND
S-1802	ZKC1206	5-1206X	55	S-6113	_____	5-5177X	5CSRL
S-7022	_____	5-124X	1800	S-6921	_____	5-5800XX	58WB
S-B821	_____	5-1300X	5160	S-6919	_____	5-5801X	58WB
S-9846	_____	5-1306X	7260	S-6920	_____	5-5802X	58WB
S-A163	_____	5-1309X	7290	S-6125	ZKC6100	5-6000X	6CL
S-7023	_____	5-134X	1310-1330	S-6109	_____	5-6102X	6CBL
S-B118	_____	5-137X	_____	S-6107	_____	5-6106X	6BL
S-2171	ZKC153	5-153X	1260-1270	S-C472	ZKC5674X	5-674X	1610 1/2 ROUND
		(5-121X)	1310	S-C473	ZKC5675X	5-675X	1710 1/2 ROUND
S-7024	ZKC155	5-155X	1550	S-C474	ZKC5676X	5-676X	1810 1/2 ROUND
S-2860	ZKC160	5-160X	1410	S-C475	ZKC5677X	5-677X	1760 1/2 ROUND
S-7025	_____	5-165X	1650	S-1720	ZKC7000	5-7000X	7LN
S-7026	ZKC170	5-170X	1000	S-6118	_____	5-7105X	7LN
S-7027	ZKC178	5-178X	1350	S-6116	ZKC7202	5-7202X	7CBL
S-7029	ZKC188	5-188X	1480	S-13211	ZKC785	5-785X	1310
S-9683	_____	5-213X	1330	S-6126	_____	5-8105X	8BL
S-7030	_____	5-260X	1310 WJ	S-6123	ZKC8200	5-8200X	8LN
S-7434	ZKC279	5-279X	1610	S-6124	_____	5-8202X	8CBL
S-7435	ZKC280	5-280X®	1710	S-8922	_____	5-9000X	9C
S-2627	ZKC281	5-281X	1810	S-6117	_____	5-9001X	9C
S-7658	_____	5-297X	1310 HDWJ	S-11158	_____	5-9017X	9C
S-13953	ZKC5308X	5-308X	1880	S-6918	ZKC92	5-92X	L6N
S-9347	_____	5-3147X	3RL	S-C186	_____	_____	850N
S-6101	_____	5-324X	1810 MACK	S-B117	_____	5-55-55-2	55
S-7889	_____	5-326X	1880	S-E129	ZKCSPL90	SPL90X®	SPL®
			TO 9C MACK	S-14117	2506391C91	SPL100-1X®	SPL®
S-C499	_____	5-328X	58WB TO 1550		1681117C91		
S-C587	_____	5-332X	1480WJ	S-E358	2500678C91	SPL170X®	SPL®
S-9845	_____	5-353X	1260, 1310 TO 7260	S-E359	2500680C91	SPL250X®	SPL®
S-6110	_____	5-4002X	4CL				
S-6099	ZKC407	5-407X	1760				
S-11832	_____	5-4140X	4CBL				
S-7618	_____	5-4143X	4BL				
S-7798	_____	5-438X	1610 1/2 ROUND				
S-7031	_____	5-469X	1760 1/2 ROUND				
S-C404	_____	5-5000X	5CL				
S-6121	_____	5-5015X	5BL				

43" X 31.5" DRIVELINE POSTERS AVAILABLE ON REQUEST
 CHECK OUT OUR ENTIRE DRIVELINE PROGRAM

LATEST ADDITIONS TO OUR CATALOG

SPL__X® and 5-280X® are registered trademarks of DANA Corporation

UNLESS OTHERWISE NOTED, ALL PARTS SUPPLIED ARE S & S/NEWSTAR. USE OF OTHER MANUFACTURERS' NAMES, PART NUMBERS, OR TRADEMARKS ARE FOR INFORMATIONAL AND IDENTIFICATION PURPOSES ONLY.



COMPLETE PARTS LISTING

NUMERICAL LISTING OF PART NUMBERS SUITABLE FOR INTERNATIONAL TRUCK

NEWSTAR NUMBER	REPLACEMENT FOR INTERNATIONAL TRUCK NUMBER	DESCRIPTION	NEWSTAR NUMBER	REPLACEMENT FOR INTERNATIONAL TRUCK NUMBER	DESCRIPTION
S-2970	10454VA	SPRING QTY PKG 10 EA.	S-5422	1653055C91	PIN KIT
S-7440	105C137	CLUTCH RELEASE FORK	S-7873	1653421C91	VALVE
S-5056	110362R92	TIE ROD END	S-8733	1654269C1	SPRING SHACKLE
S-5057	110363R92	TIE ROD END	S-B216	1654717C91	MODEL BB POWER STEERING PUMP
S-D895	1115556	SOLENOID SWITCH	S-B163	1654771C91	VNF POWER STEERING PUMP
S-E555	1115598	SOLENOID SWITCH	S-C100	1654852C91	BEARING
S-B038	127740	CLUTCH BRAKE	S-C101	1654853C91	BEARING
S-B039	127760	CLUTCH BRAKE	S-C102	1654854C1	BEARING
S-7625	130704R1	RADITOR CAP	S-4730	165519R91	HORN
S-4215	131020R11	SCREW	S-B216	1655606C91	MODEL BB POWER STEERING PUMP
S-3144	131028R1	SPRING	S-B216	1655607C91	MODEL BB POWER STEERING PUMP
S-5065	135262R1	WHEEL	S-17180	1657064C91	OIL SEAL KIT
S-2935	143240R91	OIL PRESSURE SENDER	S-A125	1657277C91	HALF ROUND END YOKE
S-16983	144422H	LOCK NUT	S-A138	1657280C91	HALF ROUND END YOKE
S-7622	144424H	NUT QTY PKG 10 EA.	S-A126	1657349C91	END YOKE
S-5070	144425H	NUT	S-D756	1658128C91	STRAP KIT
S-5074	151067R3	GASKET	S-A782	1658443C91	BRAKE CALIPER (NO CORE CHARGE)
S-5075	151102R2	GASKET	S-9127	1658820C1	AIR SWITCH, LOW PRES
S-2023	151115R31	FLYWHEEL	S-B613	1658833C91	STRAP KIT
S-5076	151189R1	PUSH ROD	S-A955	1658834C91	STRAP KIT
S-4628	151363R1	BOLT	S-A293	1658835C91	STRAP KIT
S-4519	151364R1	BOLT	S-4988	1658934C93	KING PIN SET
S-2935	1513678C92	OIL PRESSURE SENDER	S-F505	1658946C91	TIE ROD END
S-A414	1514626C1	U-BOLT	S-F506	1658947C91	TIE ROD END
S-3302	151728R21	DIPSTICK	S-9304	1660271C92	KING PIN SET
S-8641	153179R1	FLANGE YOKE	S-B618	1660414C1	HALF ROUND END YOKE
S-5080	157490R1	RIVET	S-B431	1660417C1	HALF ROUND END YOKE
S-4261	157494R1	WASHER	S-F116	1660419C1	STUB SHAFT
S-6359	157518R2	AXLE SHAFT	S-F117	1660420C1	STUB SHAFT
S-5242	1606881C1	SHACKLE	S-9094	1661234C3	HEADLIGHT SWITCH
S-5082	161060R1	RIVET	S-14067	1661281C91	TAILLIGHT
S-4018	161061R2	WASHER QTY PKG 12 EA.	S-9166	1661282C91	LAMP
S-4017	161064R1	WASHER	S-9436	1661381C1	BREAKER
S-B216	1614025C91	MODEL BB POWER STEERING PUMP	S-9437	1661383C1	BREAKER
S-B207	1615247C91	V20NF POWER STEERING PUMP	S-A719	1661437C92	DRAG LINK ASSEMBLY
S-9729	1616317C91	TURN SIGNAL SWITCH	S-4731	166166R91	HORN
S-D895	1618940C1	SOLENOID SWITCH	S-10407	1661843C1	WINDSHIELD WIPER MOTOR
S-8997	1619114C5	TANK	S-7890	1661919C5	SURGE TANK
S-5083	162210R1	CLIP QTY PACK 25 EA.	S-7580	1661976C3	SPRING PIN
S-4635	162280R91	CONTROL	S-7017	1662086C91	END YOKE
S-E178	1622366C91	SWITCH	S-B996	1662139C91	END YOKE
S-4636	162337R93	REGULATOR	S-9167	1662143C91	END YOKE
S-4252	1646750C1	DISC PAD SET	S-9035	1662145C91	END YOKE
S-9104	1646970C1	SWITCH, BACK-UP LITE	S-9029	1662153C91	END YOKE
S-B215	1647567C91	MODEL BB POWER STEERING PUMP	S-7455	1662162C1	WELD YOKE
S-5087	1648109C1	SPRING PIN	S-B614	1662181C91	U-BOLT KIT
S-5088	1648110C1	SPRING PIN	S-B615	1662182C91	U-BOLT KIT
S-8030	1648162C91	SLAVE VALVE	S-8549	1662245C91	END YOKE
S-5916	1648173C91	GASKET SET	S-9027	1662246C91	END YOKE
S-5223	1648204C92	KING PIN SET	S-7582	1662252C91	END YOKE
S-9415	1649492C1	WHEEL NUT	S-2659	1662253C91	END YOKE
S-7459	1649637C91	TIE ROD END L.H.	S-1980	16622711C91	CENTER BEARING
S-7460	1649638C91	TIE ROD END R.H.	S-7935	1662709C91	CENTER BEARING
S-8530	1649776C1	DOOR HANDLE,WIN. REG	S-7934	1662710C91	CENTER BEARING
S-B991	1649804C1	END YOKE	S-1980	1662711C91	CENTER BEARING
S-3359	1651261C91	CASE ASSEMBLY	S-D458	1662712C91	CENTER?BEARING
S-4974	1651264C91	CASE ASSEMBLY	S-D460	1662713C91	CENTER BEARING
S-4660	1651268C91	GEAR KIT	S-D459	1662722C91	CENTER BEARING
S-5143	1651274C91	GEAR KIT	S-7926	1662725C91	CENTER BEARING
S-4709	1651275C91	GEAR KIT	S-8643	1662804C1	SLIP YOKE
S-4732	1651276C91	GEAR KIT	S-B608	1662835C91	STRAP KIT
S-9778	1651280C91	OIL SEAL	S-B609	1662836C91	STRAP KIT
S-5478	1651281C91	SEAL	S-B612	1662883C91	STRAP KIT
S-9454	1651404C91	CABLE	S-D484	1663204C91	POWER STEERING PUMP
S-5623	1651805C91	MAIN DRIVE GEAR	S-9494	1663595C91	TURN SIGNAL SWITCH
S-E247	1651826C1	SPACER .910	S-A392	1663625C91	KIT M100
S-B215	1651836C91	MODEL BB POWER STEERING PUMP	S-A392	1663626C91	KIT M100
S-D837	1651911C1	SEAL	S-E036	1663631C1	SECTOR SHAFT
S-7983	1651917C91	GEAR KIT	S-B216	1664376C91	MODEL BB POWER STEERING PUMP
S-9348	1652306C91	IGNITION SWITCH	S-B215	1664377C91	MODEL BB POWER STEERING PUMP
S-9348	1652307C91	IGNITION SWITCH	S-D905	1664723C3	INSULATOR



LATEST ADDITIONS TO OUR CATALOG

UNLESS OTHERWISE NOTED, ALL PARTS SUPPLIED ARE S & S/NEWSTAR. USE OF OTHER MANUFACTURERS' NAMES, PART NUMBERS, OR TRADEMARKS ARE FOR INFORMATIONAL AND IDENTIFICATION PURPOSES ONLY. .

COMPLETE PARTS LISTING

NUMERICAL LISTING OF PART NUMBERS SUITABLE FOR INTERNATIONAL TRUCK

NEWSTAR NUMBER	REPLACEMENT FOR INTERNATIONAL TRUCK NUMBER	DESCRIPTION	NEWSTAR NUMBER	REPLACEMENT FOR INTERNATIONAL TRUCK NUMBER	DESCRIPTION
S-D906	1664726C2	INSULATOR	S-E629	1681119C1	STUB SHAFT
S-D894	1664788C2	SHOCK ABSORBER	S-9497	1681130C93	STEERING GEAR
S-E248	1665324C1	SPACER	S-9442	1681254C1	RELAY
S-A580	1665325C91	KIT	S-B237	1681352C91	GASKET SET
S-A469	1665329C91	BEARING & SEAL KIT	S-17041	1682625C91	POWER STEERING PUMP
S-8757	1665332C1	SHIFT COLLAR	S-B216	1684290C91	MODEL BB POWER STEERING PUMP
S-D594	1665334C1	POWER DIVIDER SHAFT	S-9440	1684364C7	FUEL SENDER GAUGE
S-9275	1665379C91	OUTPUT SHAFT	S-D756	1685128C91	STRAP KIT
S-B216	1665551C91	MODEL BB POWER STEERING PUMP	S-A973	1685173C1	LOCK NUT
S-B215	1665552C91	MODEL BB POWER STEERING PUMP	S-A392	1685195C91	STEERING GEAR KIT
S-C076	1666086C91	END YOKE	S-A392	1685195C93	KIT M100
S-B216	1666272C91	MODEL BB POWER STEERING PUMP	S-A392	1685196C91	STEERING GEAR KIT
S-B214	1667498C91	MODEL BB POWER STEERING PUMP	S-A392	1685196C93	KIT M100
S-A764	1668224C91	TIE ROD END	S-9409	1686704C91	WINDOW REGULATOR, L,H
S-A765	1668225C91	TIE ROD END	S-9410	1686705C91	WINDOW REGULATOR, RH
S-B599	1668409C91	TIE ROD END	S-A644	1686721C91	LIGHT ASSEMBLY
S-B600	1668410C91	TIE ROD END	S-D589	1686736C91	RESERVOIR
S-A483	1668411C92	KING PIN SET	S-A604	1688312C1	BUZZER, WARNING
S-13563	1668412C91	KING PIN SET	S-C379	1688314C1	RELAY
S-E445	1668428C1	SECTOR SHAFT	S-9727	1689991C91	TURN SIGNAL SWITCH
S-15180	1668441C92	INPUT (WORM) SHAFT	S-D590	1691121C1	FILTER ELEMENT
S-B231	1668479C91	TIE END ROD	S-D591	1691125C1	OIL LEVEL GAUGE
S-B230	1668480C91	TIE END ROD	S-A737	1691143C2	OIL SEAL, PINION
S-7565	166880R1	PEDAL PAD	S-9496	1691153C91	RETAINER W/SEAL
S-D629	1668900C92	RADIATOR, MEDIUM DUTY	S-7247	1691154C91	RETAINER
S-17264	1668901C92	RADIATOR	S-A645	1691210C1	RETAINER RING
S-A917	1669311C91	BRAKE CALIPER, TWIN PISTON (NO CORE CHARGE)	S-7198	1692999C91	HF70 MASTER KIT
S-B214	1669412C91	MODEL BB POWER STEERING PUMP	S-C097	1693034C1	GEAR-COUNTERSHAFT
S-B333	1669550C91	CENTER BEARING	S-B236	1693373C91	GASKET SET
S-8730	1669746C91	PULLEY	S-8336	1693397C91	SLAVE VALVE KIT
S-8583	1669786C1	MOTOR	S-A649	1693479C91	SOLENOID SWITCH
S-5965	1670556C91	VALVE	S-4664	1694297C91	SWITCH
S-7627	1671216C93	STEERING GEAR KIT	S-C703	1694689C91	INPUT SHAFT
S-B216	1671589C91	MODEL BB POWER STEERING PUMP	S-9767	1694952C91	CABLE ASSEMBLY
S-7579	1671766C1	SPRING PIN	S-C367	1695714C91	DRAG LINK END
S-B216	1671876C91	MODEL BB POWER STEERING PUMP	S-B390	1695989C91	HUBCAP
S-5222	1672105C91	CLAMP	S-9720	1696471C1	NUT
S-9443	1672537C1	RELAY	S-A796	1696472C1	NUT, IDLER GEAR
S-9414	1674053C1	TURBO CLAMP	S-3929	1696474C1	NUT
S-9501	1675137C91	TAS40 REBUILD KIT	S-14004	1696499C1	NOZZLE
S-9502	1675138C91	TAS55 REBUILD KIT	S-B246	1696994C91	BOLT KIT
S-4740	1675448C1	NUT QTY PACK 25 EA.	S-16536	1697273C2	RADIATOR
S-9459	1675696C91	HANDLE	S-A646	1697356C1	RETAINER RING
S-4229	1675871C91	HAND BRAKE LEVER	S-C302	1698113C1	BUSHING
S-C105	1675872C91	HAND BRAKE ASSEMBLY	S-A824	1699216C91	SWITCH W/CONNECTOR
S-B215	1675898C91	MODEL BB POWER STEERING PUMP	S-9660	1699291C1	BLOWER MOTOR
S-A943	1676238C91	PAWL ASSEMBLY	S-A287	1699929C91	HOLD DOWN KIT
S-7934	1676270C91	CENTER BEARING	S-688	1712VA	COLLAR
S-1980	1676271C91	CENTER BEARING	S-4641	178417R92	EMERGENCY BRAKE BAND
S-7020	1676273C91	CENTER BEARING	S-4443	1802338C91	CAMSHAFT
S-7926	1676305C91	CENTER BEARING	S-4443	1802339C92	CAMSHAFT
S-F427	1676648C1	BLOWER MOTOR	S-4443	1802506C91	CAMSHAFT
S-3139	1677045C1	GASKET	S-5966	1804027C2	BOLT QTY PKG 17 EA.
S-D448	1677092C1	SYNCHRO HUB	S-7782	1804038C1	WASHER QTY PKG 34 EA.
S-B215	1677288C91	MODEL BB POWER STEERING PUMP	S-9715	1804211C2	GLOW PLUG
S-17328	1677432C91	LATCH	S-7542	1804495C93	FUEL PUMP
S-17329	1677433C91	LATCH	S-8729	1805398C94	OIL PUMP
S-17330	1677434C2	DOOR LOCK	S-7800	180561R92	DISC
S-17352	1677435C2	DOOR LOCK	S-A729	1806793C1	SPRING, ACCELERATOR
S-8255	1677540C91	R-14 RELAY VALVE	S-9261	1807917C1	GLOW PLUG
S-6006A	1677541C91	R-12 RELAY VALVE	S-6007	1807974C94	THERMOSTAT
S-A422	1677672C92	SYNCHRONIZER	S-5272	1808973C91	OVERHAUL SET
S-E849	1677713C1	SIGHT GLASS	S-8185	1809058C2	BOLT QTY PKG 17 EA
S-17569	1680517C93	PARKING BRAKE CABLE	S-8185	1809058C2	BOLT
S-E627	1680789C91	DOOR LATCH	S-A856	1809144C91	FLYWHEEL
S-8898	1681044C91	PP1 VALVE	S-9168	1809497C1	DIPSTICK
S-5890	1681047C91	POWER STEERING PUMP	S-4088	180958R91	HINGE
S-B164	1681049C91	V10NF POWER STEERING PUMP	S-A608	1810855C93	FLYWHEEL
S-14117	1681117C91	UNIVERSAL JOINT	S-C613	1811049C91	HEAD GASKET SET
S-13682	1681118C1	WELD YOKE	S-C614	1811050C91	HEAD GASKET SET
			S-C615	1813067C93	INTAKE VALLEY PAN GASKET

LATEST ADDITIONS TO OUR CATALOG

UNLESS OTHERWISE NOTED, ALL PARTS SUPPLIED ARE S & S/NEWSTAR. USE OF OTHER MANUFACTURERS' NAMES, PART NUMBERS, OR TRADEMARKS ARE FOR INFORMATIONAL AND IDENTIFICATION PURPOSES ONLY. .



COMPLETE PARTS LISTING

NUMERICAL LISTING OF PART NUMBERS SUITABLE FOR INTERNATIONAL TRUCK

NEWSTAR NUMBER	REPLACEMENT FOR INTERNATIONAL TRUCK NUMBER	DESCRIPTION	NEWSTAR NUMBER	REPLACEMENT FOR INTERNATIONAL TRUCK NUMBER	DESCRIPTION
S-E803	1815538C91	WATER PUMP	S-A392	2502008C91	KIT M100
S-5272	1817254C96	OVERHAUL SET	S-D421	2502009C92	STEERING GEAR KIT
S-B473	1817687C91	WATER PUMP	S-4740	2502028C1	NUT QTY PACK 25 EA.
S-B473	1817687C96	WATER PUMP (NEW OUTRIGHT ... NO CORE CHARGE)	S-16535	2502718C1	RADIATOR
S-10006	1818214C91	FLYWHEEL	S-F429	2503267C91	BLOWER MOTOR
S-B072	1818727C1	GASKET	S-E914	2504006C91	TORQUE ROD
S-9261	1819649C1	GLOW PLUG	S-6031	2504714C1	CAP
S-3239	1819891C91	FLYWHEEL	S-16537	2505159C91	RADIATOR
S-5331	1820953C4	DIPSTICK	S-15315	2505649C91	SURGE TANK
S-10005	1821915C93	FLYWHEEL	S-14117	2506391C91	UNIVERSAL JOINT
S-B473	1830606C93	WATER PUMP	S-E715	2507286C91	STRAP KIT
S-13248	1831676C92	WATER PUMP	S-10130	2509253C91	BRAKE CALIPERS (NO CORE CHARGE)
S-17343	1841217C91	IPR VALVE	S-10131	2509254C91	BRAKE CALIPERS (NO CORE CHARGE)
S-17036	1842664C91	WATER PUMP	S-14677	2509380C91	FAN CLUTCH KIT
S-5094	18521R1	M.S. NUT	S-E585	254468C1	SCREW
S-E230	19020302	ALTERNATOR	S-5133	258087C91	THERMOSTAT
S-E231	19020305	ALTERNATOR	S-3218	258387C2	PIPE
S-E232	19020306	ALTERNATOR	S-16534	2585978C93	RADIATOR
S-15369	19020388	ALTERNATOR	S-C556	258894C1	GASKET
S-5102	193989R1	SPRING PIN	S-4651	25893R1	NUT
S-4155	19499R1	NUT	S-11558	2589611C91	STEERING GEAR KIT
S-E225	1990379	STARTER	S-7598	260551C91	WHEEL CYLINDER
S-E227	1990456	STARTER	S-4155	26244R1	NUT
S-E226	1990483	STARTER	S-12090	263498C91	TIE ROD END
S-A213	2000231C1	LOCK NUT	S-12091	263499C91	TIE ROD END
S-16538	2000985C93	RADIATOR	S-3103	265211C94	VALVE ASSY
S-3780	200106R1	INSULATOR	S-4654	266389C91	HOOD CATCH
S-11182	2002875C91	TURN SIGNAL SWITCH	S-5124	268574C95	ROTOR
S-7622	2003027C1	NUT	S-4112	268690C91	BUZZER
S-6529	200479591	AIR FILTER ASSY.	S-5126	277055C91	RELAY
S-17552	2005337C91	POWER STEERING PUMP	S-7214	281817C96	BEARING & SEAL KIT
S-A638	2010529C91	CABLE	S-7935	283067C93	CENTER BEARING
S-9731	2012260C1	BELT	S-1980	283069C93	CENTER BEARING
S-9443	2012557C1	RELAY	S-7926	283071C93	CENTER BEARING
S-D894	2015556C1	SHOCK ABSORBER	S-5780	283360C1	END YOKE
S-13490	2018471C1	MUFFLER	S-7454	284642C1	STUB SHAFT
S-F385	2018987C1	SHOCK ABSORBER	S-2011	284680C1	END YOKE
S-C380	2026910C1	RELAY	S-4658	285308C2	STRAP
S-D894	2032533C1	SHOCK ABSORBER	S-2888	286324C2	INSULATOR
S-15593	2032580C95	LUGGAGE BOX CABLE	S-4659	286583C92	CASE & SHAFT
S-11183	2034257C91	TURN SIGNAL SWITCH	S-3204	286655C4	SHIFT BOOT
S-9620	2040568C91	INDICATOR LIGHT	S-5129	287116C91	CONTROL
S-A174	2040733C1	EASY SERVICE YOKE	S-4422	288219C1	THROTTLE BODY
S-17348	2040848C	FUEL CAP	S-8931	288905C91	SHIFT VALVE
S-2409	206258R1	SPRING PIN	S-630	290862C91	INSULATOR
S-2409	206258R3	SPRING PIN	S-1980	291870C91	CENTER BEARING
S-8018	21015R1	HFB52 RETAINING RING	S-4664	295417C91	SWITCH
S-8647	211259R1	FLANGE YOKE	S-4523	301701C1	SHACKLE
S-3832	212013R1	GASKET	S-6938	303136C92	KING PIN SET
S-8931	213909R1	SHIFT VALVE	S-6947	303139C91	KING PIN SET
S-1963	217158R92	TAPPET	S-6946	303140C92	KING PIN SET
S-5105	21814H	NUT QTY PACK 25 EA.	S-2680	303859C1	SPRING PIN
S-4601	22397V	BEARING	S-2357	303865C1	SPRING PIN
S-4221	229998R1	SHAFT	S-5132	306921C93	KING PIN SET
S-3502	232040R91	LINED BRAKE SHOE	S-7664	311175C91	BELT
S-9046	232049R1	BACKING PLATE	S-7020	315442C91	CENTER BEARING
S-9046	232049R11	BACKING PLATE	S-5275	315446C92	CABLE
S-3145	233009R1	SPRING QTY PACK 10 EA.	S-3307	317811C94	O-RING KIT
S-3886	233010R11	STRUT	S-5133	319340C91	THERMOSTAT
S-5115	241120R91	SWITCH	S-3888	322069C91	BUSHING
S-5116	244283R91	HORN	S-4056	324888C93	HEAT REGULATOR
S-D757	2500674C91	STRAP KIT	S-4673	336079R91	CAP
S-D758	2500675C91	STRAP KIT	S-7208	336276R92	OIL SEAL
S-E358	2500678C91	UNIVERSAL JOINT	S-8797	337090C91	VALVE WITH KNOB
S-E359	2500680C91	UNIVERSAL JOINT	S-4675	338614C1	CLAMP
S-B047	2500818C1	CABLE CYLINDER	S-C120	338914C1	STRUT
S-10131	2501838C91	BRAKE CALIPERS (NO CORE CHARGE)	S-4676	340107C92	SEAL
S-10130	2501839C91	BRAKE CALIPERS (NO CORE CHARGE)	S-5135	341035C91	WHEEL CYLINDER
S-13998	2501841C91	BRAKE PADS	S-3050	341036C91	WHEEL CYLINDER
S-13997	2501842C91	BRAKE PADS	S-5137	341037C91	WHEEL CYLINDER
			S-5138	341038C91	WHEEL CYLINDER



LATEST ADDITIONS TO OUR CATALOG

UNLESS OTHERWISE NOTED, ALL PARTS SUPPLIED ARE S & S/NEWSTAR. USE OF OTHER MANUFACTURERS' NAMES, PART NUMBERS, OR TRADEMARKS ARE FOR INFORMATIONAL AND IDENTIFICATION PURPOSES ONLY. .

COMPLETE PARTS LISTING

NUMERICAL LISTING OF PART NUMBERS SUITABLE FOR INTERNATIONAL TRUCK

NEWSTAR NUMBER	REPLACEMENT FOR INTERNATIONAL TRUCK NUMBER	DESCRIPTION	NEWSTAR NUMBER	REPLACEMENT FOR INTERNATIONAL TRUCK NUMBER	DESCRIPTION
S-4678	343361C1	TIP	S-5370	406280C1	BUSHING
S-C319	344649C1	SPACER .195"	S-4729	408103C1	GASKET, HUB CAP
S-C320	344655C1	SPACER .201"	S-6663	408547C93	KING PIN SET
S-C321	344661C1	SPACER .207"	S-4730	411948C91	HORN
S-3600	344688C91	SWITCH	S-4731	411949C91	HORN
S-3137	346130C1	SHACKLE	S-7668	41339D	RETAINER QTY PKG 16
S-17314	3505300C1	RELAY	S-4433	414051C1	BOLT QTY PACK 25 EA.
S-7580	3511254C1	SPRING PIN	S-4434	414052C1	BOLT QTY PACK 25 EA.
S-11797	3514952C91	SHOCK ABSORBER	S-4435	414053C1	BOLT QTY PACK 25 EA.
S-17608	3516015C1	RELAY	S-4436	414054C1	BOLT QTY PACK 25 EA.
S-17570	3523179C92	HORN	S-4437	414055C1	BOLT QTY PACK 25 EA.
S-17571	3523180C92	HORN	S-4438	414056C1	BOLT QTY PACK 25 EA.
S-10407	3528713C91	WINDSHIELD WIPER MOTOR	S-4440	414058C1	BOLT QTY PACK 15 EA.
S-11177	3531661C2	BRAKE ROTOR	S-4505	414076C1	BOLT QTY PACK 15 EA.
S-E743	3531662C91	BRAKE ROTOR	S-4733	414077C1	BOLT QTY PACK 25 EA.
S-13295	3531663C2	BRAKE ROTOR	S-4734	414078C1	BOLT QTY PACK 25 EA.
S-10407	3539699C91	WINDSHIELD WIPER MOTOR	S-4735	414079C1	BOLT QTY PACK 15 EA.
S-E627	3550925C91	DOOR LATCH	S-4736	414080C1	BOLT QTY PACK 15 EA.
S-E627	3550930C91	DOOR LATCH	S-5861	414081C1	BOLT QTY PACK 15 EA.
S-E627	3550931C91	DOOR LATCH	S-5862	414082C1	BOLT QTY PACK 15 EA.
S-17265	3555029C1	SHIFT CABLE	S-4442	414084C1	BOLT QTY PACK 15 EA.
S-17266	3555030C1	SHIFT CABLE	S-4737	414087C1	NUT QTY PACK 50 EA.
S-11605	3558776C1	HOOD LATCH	S-4738	414089C1	NUT QTY PACK 50 EA.
S-4684	356005R1	O-RING QTY PKG 20 EA.	S-2245	41419V	NUT
S-5666	356623C1	WELD YOKE	S-2889	41420V	NUT
S-7457	356660C1	WELD YOKE	S-4739	416372C1	SWITCH
S-7433	356663C92	SLIP YOKE	S-C635	416734C1	FLANGE BOLT 3/4" - 16 - 2"
S-7432	356677C92	SLIP YOKE	S-7604	416736C2	BOLT, HEX HEAD
S-7458	356679C1	JOINT STUB	S-14718	416739C1	BOLT
S-11182	3566936C91	TURN SIGNAL SWITCH	S-4740	416743C1	NUT QTY PACK 25 EA.
S-11183	3566941C91	TURN SIGNAL SWITCH	S-2248	417834C1	HOUSING
S-14653	3580088C91	TORQUE ROD	S-5569	418324C91	SLIP YOKE
S-E913	3581271C1	TORQUE ROD	S-5174	421843C1	MOTOR
S-4687	358560C1	SWITCH	S-5848	421913C1	NUT
S-5222	3586939C1	CLAMP	S-3291	422159C92	SLAVE VALVE ASSY
S-7205	358922C91	OIL SEAL	S-2022	422162C1	REGULATOR VALVE
S-13603	3596382C91	FUEL SENDER	S-A525	422479C91	V20F POWER STEERING PUMP
S-9443	3607384C1	RELAY	S-4440	424058C1	BOLT
S-5142	361764C1	POINT SET	S-4746	424469C93	OIL SEAL W/SLEEVES
S-4690	361974C1	ESCUTCHEON	S-5380	425866C1	STUB SHAFT
S-3774	363048C92	SPLITTER VALVE	S-4868	425934C1	CAM STUD
S-5665	363080C91	SLIP YOKE	S-8361	428186R93	E-3 VALVE
S-7600	36416HB	LOCK	S-3600	429047C1	SWITCH
S-5173	371498C91	SEAL	S-8011	431023C94	SELECTOR VALVE
S-8936	374297C92	THRUST BEARING	S-4751	433178C1	BREAKER
S-5328	379318C1	OIL CAP	S-7988	434031C91	PUMP KIT
S-14693	3803402	WATER PUMP	S-2523	434297C1	SWITCH
S-14694	3803403	WATER PUMP	S-9031	435642C91	END YOKE
S-D893	3803605	WATER PUMP	S-8000	435673C1	PISTON RING
S-D457	383182C91	CENTER BEARING	S-9263	435686C1	SEAL
S-4697	384792C91	HOSE	S-7943	435854C91	SECTOR SHAFT
S-5157	386025C1	CONTACT	S-9027	436032R1	END YOKE
S-4215	386071C11	SCREW	S-8420	438286C1	FRAME BOLT
S-7656	386398C91	SAFETY VALVE	S-7942	438758C1	BRONZE BUSHING
S-7934	386418C91	CENTER BEARING	S-4754	439100C1	CABLE
S-14699	38713RA	REPAIR KIT	S-3929	440302C1	NUT
S-5285	388249C1	GASKET	S-3199	441246C1	KEY
S-4700	388355C1	NUT	S-4879	441337C2	EXHAUST RING
S-A173	388912C91	LINED BRAKE SHOE	S-5988	442354C93	TIE ROD END R.H.
S-C120	388914C1	STRUT	S-4882	443864C2	PIN
S-7199	390491C91	SEAL	S-4883	444659C91	LAMP
S-8253	391862C1	STUB SHAFT	S-4883	444660C91	LAMP
S-15543	393442ASSY	SWITCH & KNOB ASSY	S-4762	446452C1	GASKET
S-4356	393442C1	SWITCH	S-3927	446615R1	END YOKE
S-4585	394120C91	TANK	S-7667	446839C1	GSKT MAKER QTY PK 12 EA.
S-4234	396873C1	SHIM	S-7459	447094C91	TIE ROD END L.H.
S-4707	400745C92	DRAG LINK ASSEMBLY	S-7460	447095C91	TIE ROD END R.H.
S-2526	401097C3	SHIFT FORK 2ND & 3RD	S-5971	447186C1	TURN SIGNAL, RELAY
S-3852	404618C1	PUMP	S-C453	449131C91	AIR REGULATOR
S-4710	405367C91	SEAL	S-9409	449766C93	WINDOW REGULATOR LH
S-4728	405368C91	SEAL	S-9410	449767C93	WINDOW REGULATOR, RH

LATEST ADDITIONS TO OUR CATALOG

UNLESS OTHERWISE NOTED, ALL PARTS SUPPLIED ARE S & S/NEWSTAR. USE OF OTHER MANUFACTURERS' NAMES, PART NUMBERS, OR TRADEMARKS ARE FOR INFORMATIONAL AND IDENTIFICATION PURPOSES ONLY. .



COMPLETE PARTS LISTING

NUMERICAL LISTING OF PART NUMBERS SUITABLE FOR INTERNATIONAL TRUCK

NEWSTAR NUMBER	REPLACEMENT FOR INTERNATIONAL TRUCK NUMBER	DESCRIPTION	NEWSTAR NUMBER	REPLACEMENT FOR INTERNATIONAL TRUCK NUMBER	DESCRIPTION
S-4767	450062C91	TIE ROD END L.H.	S-7995	482350C91	SEAL
S-4768	450063C91	TIE ROD END R.H.	S-7020	484002C91	CENTER BEARING
S-D837	450964C1	SEAL	S-9120	486530C1	STUB SHAFT
S-6950	452344C91	KING PIN SET	S-8933	487320C91	THRUST BEARING
S-4771	452950C91	E-6 BRAKE VALVE	S-8020A	487333C1	SEAL
S-4773	453694C3	CABLE	S-8021	487339C91	SEAL
S-2938	454925C1	SWITCH	S-8022	487340C1	SEAL
S-4894	455460C1	AXLE SHAFT	S-4935	487344C91	SECTOR SHAFT
S-4896	455461C2	AXLE SHAFT	S-8029	487359C1	HFB52 SUPPORT RING
S-3331	455463C2	AXLE SHAFT	S-8024	487360C1	HFB52 STEEL BACK UP WASHER
S-4896	455464C2	AXLE SHAFT	S-8025	487361C1	SEAL
S-4898	455975C92	VALVE	S-4936	487364C91	HFB52 SECTOR SHAFT
S-4779	456646C1	BALL JOINT	S-E324	487680C1	CLUTCH SHAFT
S-A272	459271C92	SR-1 VALVE	S-8327	488499C2	CABLE
S-6085	459790C91	RG-2 RELAY VALVE	S-5897	488787C91	POWER STEERING PUMP
S-3370	463346C1	BEARING	S-4603	489023C91	DRAG LINK ASSEMBLY
S-C312	463425C1	SPACER 1.287"	S-7671	489256C1	GASKET QTY PKG 10 EA.
S-C313	463426C1	SPACER 1.292"	S-5494	490694C91	SELECTOR VALVE
S-C314	463427C1	SPACER 1.297"	S-8800	490695C91	SELECTOR VALVE
S-C315	463428C1	SPACER 1.302"	S-3061	491668C92	HOOD CATCH KIT
S-C316	463429C1	SPACER 1.307"	S-8005	492358C1	OIL SEAL
S-4577	463430C2	CLUTCH	S-4945	493068C1	CONDENSOR
S-5478	464244C2	SEAL	S-3596	493092C92	KING PIN SET
S-4908	464248C1	BEARING	S-4948	493094C95	KING PIN SET
S-4782	465458C91	LIGHT ASSY W/BEZEL	S-4949	493095C92	KING PIN SET
S-3072	465916C1	U-BOLT	S-4811	493115C91	POWER STEERING PUMP
S-C448	466505C91	CENTER BEARING	S-7997	493133C91	BEARING
S-A646	466857C1	RETAINER RING	S-4336	493141C91	KIT
S-4912	467537C91	CAP	S-4950	493143C91	KIT
S-3600	468438C91	SWITCH	S-D629	493349C3	RADIATOR
S-3959	468699C1	SHACKLE	S-D630	493359C4	RADIATOR
S-5087	468703C2	SPRING PIN	S-D631	493367C4	RADIATOR
S-5088	468704C2	SPRING PIN	S-E913	493920C3	TORQUE ROD
S-13970	469859C1	KNOB	S-13495	495024C1	RETAINING RING
S-2729	470031C2	INSULATOR	S-D892	497501C2	BUSHING
S-4792	470421C1	LOCK	S-9439	497840C96	FUEL SENDER
S-4793	470422C1	LOCK	S-C317	497865C1	SPACER 1.312"
S-C403	471209C1	LQ-2 LIMITING VALVE	S-C318	497866C1	SPACER 1.317"
S-4513	471302C91	TURN SIGNAL SWITCH	S-7630	498003C2	DOOR LATCH, L/H
S-2983	472697C1	BUMPER	S-7631	498004C2	DOOR LATCH, R/H
S-4921	472698C1	GUIDE	S-7670	498144C1	FILTER ELEMENT
S-4033	472925C91	POWER STEERING KIT	S-8043	499523C3	RUBBER STRAP,HD LTCH
S-4412	472933C91	HF64 STEERING GEAR KIT	S-7547	500016C1	AXLE GSKT=QTY PKG 10 EA.
S-4922	473794C91	QR-1 VALVE	S-A287	500269A	HOLD DOWN KIT
S-3693	474018C1	CASE	S-3136	500269C1	HANDLE, HOOD LATCH
S-4923	474086C1	MOTOR	S-5588	500270C1	RETAINER, HOOD LATCH
S-9264	474419C91	SEAL	S-5589	500271C1	CATCH, HOOD LATCH
S-4924	474517C2	GASKET ELIMINATOR	S-9041	500273C1	PIN QTY PACK OF 10 EA.
S-8002	474577C91	HF94 PISTON RING	S-A514	500274C1	CLIP
S-6034	475173C4	ACCELERATOR CABLE	S-14653	501565C2	TORQUE ROD
S-C396	475174C5	ACCELERATOR CABLE	S-4955	50325R1	NUT
S-6034	475177C3	CABLE	S-8728	503359C1	BUSHING, CAB PIVOT
S-3200	475196C1	HANDLE	S-3938	503579C1	BUSHING,ENGINE MOUNT
S-3527	475337C1	PIN	S-5421	503610C2	SHOCK ABSORBER
S-4797	476245C1	FLASHER	S-7572	503611C1	RUBBER BUSHING & PIN
S-A140	476356C92	VALVE	S-5953	503701C91	CABLE ASSEMBLY
S-9035	476823C91	END YOKE	S-5247	503959C1	SHACKLE
S-9438	476846C2	FUEL SENDER	S-4378	504810C91	FORK
S-11575	476869C1	INSULATOR	S-4719	505026C1	STOPLIGHT SWITCH
S-13951	477257C94	DOOR LOCK, L.H.	S-4817	505027C1	LOW PRESSURE IND.
S-13952	477258C94	DOOR LOCK, R.H.	S-7606	505457C1	HORN RELAY
S-4799	477854C91	CABLE	S-7979	505657C92	STEERING KIT
S-4617	478676C1	WATER TEMP GAUGE	S-6031	506017C1	CAP
S-4618	478677C1	VOLTMETER GAUGE	S-7358	506661C92	TIE ROD END R.H.
S-4619	478678C1	FUEL GAUGE	S-7357	506662C92	TIE ROD END L.H.
S-3242	478994C92	GASKET SET	S-5988	506684C91	TIE ROD END R.H.
S-3777	479237C1	INSULATOR	S-5779	507203C1	SHACKLE PIN
S-4620	479758C1	GAUGE	S-A829	507569C91	RETAINER W/BUSHING
S-3191	481739C2	SPRING QTY PKG 6 EA.	S-4376	507809C91	POWER STEERING KIT
S-4929	48175H	MASTER CYLINDER	S-4957	507810C91	POWER STEERING KIT
S-7247	481811C1	RETAINER	S-8004	507811C1	POWER STEERING SEAL RING



LATEST ADDITIONS TO OUR CATALOG

COMPLETE PARTS LISTING

NUMERICAL LISTING OF PART NUMBERS SUITABLE FOR INTERNATIONAL TRUCK

NEWSTAR NUMBER	REPLACEMENT FOR INTERNATIONAL TRUCK NUMBER	DESCRIPTION	NEWSTAR NUMBER	REPLACEMENT FOR INTERNATIONAL TRUCK NUMBER	DESCRIPTION
S-7459	507835C91	TIE ROD END L.H.	S-C330	593675C1	MAINSHAFT
S-7460	507836C91	TIE ROD END R.H.	S-4992	594189C1	SWITCH
S-7358	507837C91	TIE ROD END R.H.	S-7990	594210C91	PUMP KIT
S-7357	507838C91	TIE ROD END L.H.	S-B164	595055C91	V10NF POWER STEERING PUMP
S-3665	508054C1	FORK ASSY 4TH & 5TH	S-B215	596246C92	MODEL BB POWER STEERING PUMP
S-17331	508010C91	FUEL CAP	S-4710	596372C1	SEAL
S-7601	508999C2	FUEL SENDER GAUGE	S-A343	597148C1	SEAL
S-2661	509190C2	SWITCH	S-A344	597156C1	IDLER PIN
S-7625	530874R1	RADIATOR CAP	S-6949	597258C91	KING PIN SET
S-A526	541508C91	V20NF POWER STEERING PUMP ASSY (NEW OUTFRIGT NO CORE CHARGE)	S-9985	597577C92	EMERGENCY BRAKE SHOE SET
S-B210	541510C91	V20NF POWER STEERING PUMP	S-9033	597763C1	END YOKE
S-4961	54495R2	NUT QTY PKG 25 EA.	S-9034	597765C1	END YOKE
S-8732	546036C1	SPRING SHACKLE	S-2011	597780C1	END YOKE
S-4965	549558C91	4" FLAT BAND CLAMP STAINLESS	S-9032	597780C1	END YOKE
S-4966	549559C91	5" FLAT BAND CLAMP STAINLESS	S-9382	597781C1	END YOKE
S-6948	549800C91	KING PIN SET	S-C462	598289C91	RANGE VALVE
S-4117	549841C91	CABLE	S-C461	598290C91	RANGE VALVE
S-4967	55070R91	CYLINDER	S-C460	598291C91	RANGE VALVE
S-A782	55250	BRAKE CALIPER (NO CORE CHARGE)	S-9093	598860C1	AIR PRESSURE SWITCH
S-A917	55314	BRAKE CALIPER, TWIN PISTON (NO CORE CHARGE)	S-3155	612686R1	SHIM
S-4332	554318C1	CLAMP 4"	S-4996	61556R91	KING PIN SET
S-4333	554319C1	CLAMP 5"	S-5934	642343C2	LOW PRESSURE SWITCH
S-10130	55849	BRAKE CALIPERS (NO CORE CHARGE)	S-6654	65071H	BEARING
S-10131	55850	BRAKE CALIPERS (NO CORE CHARGE)	S-6125	65351R93	UNIVERSAL JOINT
S-4971	571347C1	AXLE SHAFT	S-3213	671827C4	GASKET
S-5892	571349C2	AXLE SHAFT	S-5272	674398C96	OVERHAUL SET
S-4972	571350C2	AXLE SHAFT	S-5211	674399C95	OVERHAUL SET
S-7965	571351C2	AXLE SHAFT	S-5001	675046C4	VALVE
S-11752	571960C	HANGER PAD	S-5002	675439C1	GUIDE
S-9208	572107C91	BEARING & SLEEVE ASSY	S-3233	675442C1	SLEEVE
S-5965	574696C91	VALVE	S-5622	675513C1	GASKET
S-7657	575656C1	NUT - QTY PKG 8 EA.	S-5005	676865C4	VALVE
S-5893	575866C1	SPRING QTY PKG 10 EA.	S-3239	681905C95	FLYWHEEL
S-A968	576746C91	2" CAP, FUEL	S-5007	681926C2	FLYWHEEL RING GEAR
S-5970	577295C1	CONTROL, DIMMER	S-C459	682506R91	AIR HORN VALVE
S-8448	578389C1	WELD YOKE	S-7217	684833R91	WHEEL CYLINDER
S-5381	578391C1	STUB SHAFT	S-5009	684834R91	WHEEL CYLINDER
S-9511	578778C2	AXLE SHAFT	S-5010	684835R91	WHEEL CYLINDER
S-5988	581063C91	TIE ROD END R.H.	S-4293	685155C94	WATER PUMP (NO CORE CHARGE)
S-5898	581694C1	WHEEL LOCK	S-4829	688460C1	HOSE
S-4983	581742C1	U-BOLT	S-5601	688951R1	BUSHING
S-A917	582024C91	BRAKE CALIPER, TWIN PISTON (NO CORE CHARGE)	S-2634	688952R1	PIN
S-4252	582028C91	DISC PAD SET	S-5358	690437C95	SEAL KIT
S-A711	582135C92	V10NF POWER STEERING PUMP	S-5331	691796C1	DIPSTICK
S-4590	582463C91	STEERING GEAR KIT	S-7440	697924R6	FORK
S-5411	583095C91	END YOKE	S-7660	697956R2	DRIVE PIN
S-9985	583503C91	EMERGENCY BRAKE SHOE	S-7660	697956R91	DRIVE PIN
S-10012	583558C1	WELD YOKE	S-B038	69883R1	TORQUE LIMITING BRAKE
S-B166	583808C91	V20F POWER STEERING PUMP	S-5014	69971R91	KING PIN SET
S-4591	583823C91	STEERING GEAR KIT	S-5015	70594R91	KING PIN SET
S-3777	583955C1	INSULATOR	S-4834	72550R1	SCREW
S-8476	583978C91	4" CLAMP	S-7194	73120R91	WHEEL CYLINDER
S-7687	583979C91	5" CLAMP	S-7193	73121R91	WHEEL CYLINDER
S-D588	584278C1	SPRING,POWER DIVIDER	S-4293	735327C91	WATER PUMP
S-B208	585929C91	V20NF POWER STEERING PUMP	S-2731	753997C93	INSULATOR
S-B209	585930C91	V20NF POWER STEERING PUMP	S-A269	764368C92	DC-4 VALVE
S-5753	586049C1	MAGNETIC PLUG	S-5017	76771R1	PIN
S-4986	586531C3	SURGE TANK	S-4676	771723C91	SEAL
S-8480	586675C91	SLIP YOKE	S-9494	775863C93	TURN SIGNAL SWITCH
S-5134	586806C93	KING PIN KIT	S-5018	777700C91	SWITCH
S-7801	588808C91	KING PIN SET	S-A271	777915C92	DV-2 VALVE
S-6659	590583C91	TIE ROD END L.H.	S-2659	783327C1	END YOKE
S-5988	590584C91	TIE ROD END R.H.	S-B149	785910C93	V10F POWER STEERING PUMP
S-13954	590684C91	DUST SHIELD SET	S-B147	789423C91	V10F POWER STEERING PUMP
S-7989	590727C91	PUMP KIT	S-B150	791242C91	V10F POWER STEERING PUMP
S-C106	591219C1	NUT	S-B148	792547C91	V10F POWER STEERING PUMP
S-6663	591945C92	KING PIN SET	S-B151	792548C91	V10F POWER STEERING PUMP
S-4229	593380C92	HAND BRAKE LEVER	S-B039	797700C91	CLUTCH BRAKE
			S-2595	80445R1	INSERT
			S-7665	83155H	NUT QTY PKG 10 EA.
			S-7666	83156H	NUT QTY PKG 10 EA.

LATEST ADDITIONS TO OUR CATALOG

UNLESS OTHERWISE NOTED, ALL PARTS SUPPLIED ARE S & S/NEWSTAR. USE OF OTHER MANUFACTURERS' NAMES, PART NUMBERS, OR TRADEMARKS ARE FOR INFORMATIONAL AND IDENTIFICATION PURPOSES ONLY. .



COMPLETE PARTS LISTING

NUMERICAL LISTING OF PART NUMBERS SUITABLE FOR INTERNATIONAL TRUCK

NEWSTAR NUMBER	REPLACEMENT FOR INTERNATIONAL TRUCK NUMBER	DESCRIPTION	NEWSTAR NUMBER	REPLACEMENT FOR INTERNATIONAL TRUCK NUMBER	DESCRIPTION
S-4836	83817HB	GASKET	S-9195	BX239357	NUT
S-5019	85366R1	ADJUSTER	S-8721	BX245835	QR-1 REPAIR KIT
S-8883	85374R91	MOTOR	S-9624	BX248433	PP-1 KNOB & PIN
S-4115	86233H	WASHER	S-A522	BX248502	KNOB KIT
S-8444	865753R92	SINGLE CHECK VALVE 1/2	S-C604	BX272817	ALCOHOL INJECTOR W/TANK
S-2597	86625R91	LOCK W/KEYS	S-6106	BX275491	AIR GOVERNOR
S-8006	868137R92	OIL SEAL	S-6106	BX275491	GOVERNOR
S-6006	86824R93	RELAY VALVE	S-11201	BX275747	TREADLE ASSEMBLY
S-4719	873706R91	STOPLIGHT SWITCH	S-9359	BX276119	E-3 MINOR REPAIR KIT
S-3643L	873925R11	RUNNING BOARD	S-B267	BX276122	TC-2 REPAIR KIT
S-3643R	873926R11	RUNNING BOARD	S-8361	BX277863	E-3 VALVE
S-918	874053R91	HANDLE	S-A269	BX278614	DC-4 VALVE
S-4861	875350R92	HOSE	S-8887	BX279000	TP-3 VALVE
S-2214	877313R92	CAP	S-5865	BX279180	R6 RELAY VALVE
S-4721	877426R91	CLAMP	S-A266	BX279416	LP-3 SWITCH
S-4424	878192R11	BRACKET	S-A147	BX279952	R-6 RELAY VALVE
S-5030	878977R92	CYLINDER	S-D821	BX280758	TR-3 INVERSION VALVE
S-4381	887525R1	GASKET	S-C342	BX280857	PP-3 REPAIR KIT
S-4726	88771HA	BEARING	S-C343	BX280858	TP-3 REPAIR KIT
S-7548	895478R2	AXLE GASKET = QTY PKG 10 EA.	S-9350	BX281126	PP-1 REPAIR KIT
S-7549	895493R2	AXLE GASKET = QTY PKG 10 EA.	S-C346	BX281127	PP-2 REPAIR KIT
S-893	911776R3	TAPPET QTY PKG 12 EA	S-7558	BX281865	RE 6 VALVE
S-4641	91888	EMERGENCY BRAKE BAND	S-A271	BX281923	DV-2 VALVE
S-5416	91916R91	BREATHER	S-C348	BX282134	DV-2 REPAIR KIT
S-4727	95905H	SPRING	S-9358	BX282812	RE-6 REPAIR KIT
S-5046	965563R91	CYLINDER	S-7656	BX284142	SAFETY VALVE
S-5048	969055R91	DRAG LINK END	S-A146	BX284760	E-7 BRAKE VALVE
S-5049	969056R91	DRAG LINK END	S-4771	BX286171	E-6 BRAKE VALVE
S-2121	969783R1	PAD	S-A272	BX286364	SR-1 VALVE
S-3139	974707R2	GASKET	S-9174	BX286370	R-8 RELAY VALVE
S-2012	977867R1	END YOKE	S-C570	BX286453	DS-2 SL/DC VALVE
S-3778	987395R3	BUSHING	S-A273	BX286500	PP-4 VALVE
S-4252	990952C93	DISC PAD SET	S-9169	BX287238	PP-8 VALVE
S-E738	990953C91	DISC PAD SET	S-9351	BX287367	PP-7 REPAIR KIT
S-D418	990956C91	CALIPER KEY KIT	S-9360	BX287368	E-6 MINOR REPAIR KIT
S-5677	994157C91	PP-7 VALVE	S-9355	BX287370	R-8 REPAIR KIT
S-3598	99530HB	SPRING PIN	S-A150	BX287376	SR-2 VALVE
S-3779	996160C1	INSULATOR	S-C353	BX287691	SR-2 REPAIR KIT
S-A173	A23722G501	LINED BRAKE SHOE	S-5677	BX288239	PP-7 VALVE
S-3502	A33722E421	LINED BRAKE SHOE	S-4922	BX288251	QR-1 VALVE
SSAF1968M	AF1968M	AIR FILTER	S-C571	BX288383	E-7 BRAKE VALVE
SSAF25139M	AF25139M	AIR FILTER	S-A274	BX288605	TP-5 VALVE
S-5421	AM600103	SHOCK ABSORBER	S-9625	BX289144	LQ-4 VALVE
S-5421	AMS600103	SHOCK ABSORBER	S-9749	BX289714	QR-1C VALVE
S-5421	AMS6886	SHOCK ABSORBER	S-9623	BX290655	PP-7 KNOB & PIN
S-C517	BX065145	BP-R1 RELAY VALVE	S-A568	BX5004336	AD-9 PURGE VALVE KIT
S-F345	BX065157	DASH CONTROL VALVE	S-A568	BX5005037	AD-9 PURGE VALVE KIT
S-4922	BX065212	QR-1 VALVE	S-D810	BX800405	AD-9 PURGE VALVE ASSEMBLY
S-F345	BX065225	AIR DRYER ASSEMBLY	S-9795	BX800516	MV-3 DASH VALVE
S-A151	BX101112	SR-4 CONTROL VALVE	S-8304	C10703419	CLUTCH ASSEMBLY
S-A152	BX101622	SR-4 CONTROL VALVE	S-8303	C10703430	CLUTCH ASSEMBLY
S-6006	BX102626	RELAY VALVE	S-8305	C10703432	CLUTCH ASSEMBLY
S-9357	BX102802	R-14 REPAIR KIT	S-8306	C10703453	CLUTCH ASSEMBLY
S-6006A	BX103009	R-12 RELAY VALVE	S-8305	C10703454B	CLUTCH ASSEMBLY
S-8255	BX103010	R-14 RELAY VALVE	S-8308	C10703522	CLUTCH ASSEMBLY
S-8255A	BX103028	R-14 RELAY VALVE	S-8307	C10703536	CLUTCH ASSEMBLY
S-A473	BX103981	AD-4 CARTRIDGE	S-8310	C10703553	CLUTCH ASSEMBLY
S-A474	BX107794	AD-9 CARTRIDGE	S-8309	C10703554	CLUTCH ASSEMBLY
S-A474	BX107796	AD-9 CARTRIDGE	S-E353	C10705059	CLUTCH ASSEMBLY
S-C338	BX109015	SR-5 REPAIR KIT	S-E352	C10706359	CLUTCH ASSEMBLY
S-C680	BX109578	AD-9 HEATER/THERMOSTAT KIT	S-8311	C10709022	CLUTCH ASSEMBLY
S-F345	BX109685	AIR DRYER ASSEMBLY	S-8312	C1070903	CLUTCH ASSEMBLY
S-C291	BX205105	ST1-VALVE	S-8314	C10709052	CLUTCH ASSEMBLY
S-8444	BX227871	SINGLE CHECK VALVE 1/2	S-8313	C10709056	CLUTCH ASSEMBLY
S-C565	BX228165	DS-1 DOUBLE CHECK VALVE	S-8315	C10709127	CLUTCH ASSEMBLY
S-A264	BX228600	SL-4 SWITCH	S-8316	C1070913	CLUTCH ASSEMBLY
S-A265	BX228750	LP-3 SWITCH	S-8317	C10709152	CLUTCH ASSEMBLY
S-C403	BX229505	LQ-2 LIMITING VALVE	S-8317	C10709159B	CLUTCH ASSEMBLY
S-A270	BX229813	QR-1 VALVE	S-E415	C10709174	CLUTCH ASSEMBLY
S-4922	BX229859	QR-1 VALVE	S-E355	C10709177	CLUTCH ASSEMBLY
S-8328	BX229860	QR-1 VALVE	S-E415	C10709180DR	CLUTCH ASSEMBLY



LATEST ADDITIONS TO OUR CATALOG

UNLESS OTHERWISE NOTED, ALL PARTS SUPPLIED ARE S & S/NEWSTAR. USE OF OTHER MANUFACTURERS' NAMES, PART NUMBERS, OR TRADEMARKS ARE FOR INFORMATIONAL AND IDENTIFICATION PURPOSES ONLY..

NEWSTAR TRUCK PARTS LISTING

NUMERICAL LISTING OF PART NUMBERS SUITABLE FOR INTERNATIONAL TRUCK

NEWSTAR NUMBER	REPLACEMENT FOR INTERNATIONAL TRUCK NUMBER	DESCRIPTION	NEWSTAR NUMBER	REPLACEMENT FOR INTERNATIONAL TRUCK NUMBER	DESCRIPTION
S-E603	C10709181	CLUTCH ASSEMBLY	S-3596	FAK4497	KING PIN SET
S-8297	C1071135	CLUTCH ASSEMBLY	S-4948	FAK4498	KING PIN SET
S-8296	C1071137	CLUTCH ASSEMBLY	S-4949	FAK4500	KING PIN SET
S-E431	C10713716	CLUTCH ASSEMBLY	S-5134	FAK4516	KING PIN SET
S-8299	C1071375	CLUTCH ASSEMBLY	S-7801	FAK4517	KING PIN SET
S-8298	C1071376	CLUTCH ASSEMBLY	S-6939	FAK4527	KING PIN SET
S-E430	C1071378	CLUTCH ASSEMBLY	S-6938	FAK4531	KING PIN SET
S-8302	C1071422	CLUTCH ASSEMBLY	S-6492	FAK4532	KING PIN SET
S-8301	C1071423	CLUTCH ASSEMBLY	S-6939	FAK4533	KING PIN SET
S-E599	C10723716	CLUTCH ASSEMBLY	S-6942	FAK4538	KING PIN SET
S-C580	C1072378	CLUTCH ASSEMBLY	S-643	FAK4539	KING PIN SET
S-E600	C10734211	CLUTCH ASSEMBLY	S-6944	FAK4540	KING PIN SET
S-E606	C10739174	CLUTCH ASSEMBLY	S-6945	FAK4541	KING PIN SET
S-E416	C10739193	CLUTCH ASSEMBLY	S-6946	FAK4542	KING PIN SET
S-E419	C10739551	CLUTCH ASSEMBLY	S-6947	FAK4544	KING PIN SET
S-E433	C10768316	CLUTCH ASSEMBLY	S-5132	FAK4547	KING PIN SET
S-E432	C1076835	CLUTCH ASSEMBLY	S-6938	FAK4548	KING PIN SET
S-E434	C1076845	CLUTCH ASSEMBLY	S-6943	FAK4550	KING PIN SET
S-E435	C1076835	CLUTCH ASSEMBLY	S-6947	FAK4551	KING PIN SET
S-8295	C1076887	CLUTCH ASSEMBLY	S-6950	FAK4553	KING PIN SET
S-E605	C10793551	CLUTCH ASSEMBLY	S-6948	FAK4555	KING PIN SET
S-E418	C10793582	CLUTCH ASSEMBLY	S-6949	FAK4558	KING PIN SET
S-E420	C10793582EZ	CLUTCH ASSEMBLY	S-6950	FAK4559	KING PIN SET
S-E354	C10795059	CLUTCH ASSEMBLY	S-6963	FAK4560	KING PIN SET
S-E438	C10803432	CLUTCH ASSEMBLY	S-6964	FAK4564	KING PIN SET
S-D574	C10805059	CLUTCH ASSEMBLY	S-6965	FAK4566	KING PIN SET
S-E437	C10806359	CLUTCH ASSEMBLY	S-8513	FAK4567	KING PIN SET
S-C310	C10839174	CLUTCH ASSEMBLY	S-8529	FAK4568	KING PIN SET
S-C308	C10839178	CLUTCH ASSEMBLY	S-8678	FAK4570	KING PIN SET
S-C309	C10839181	CLUTCH ASSEMBLY	S-6946	FAK4571	KING PIN SET
S-E440	C10839182	CLUTCH ASSEMBLY	S-6485	FAK4572	KING PIN SET
S-E441	C10839193B	CLUTCH ASSEMBLY	S-6486	FAK4573	KING PIN SET
S-C311	C10892582	CLUTCH ASSEMBLY	S-9304	FAK4582	KING PIN SET
S-E442	C10893551	CLUTCH ASSEMBLY	S-8371	FAK4583	KING PIN SET
S-C697	C10893591	CLUTCH ASSEMBLY	S-A811	FAK4601	KING PIN SET
S-E443	C10893594	CLUTCH ASSEMBLY	S-D562	FAK4610	KING PIN SET
S-E439	C10895059	CLUTCH ASSEMBLY	S-5223	FAK5444	KING PIN SET
S-B068	DCX004478	FLAT BAND CLAMP 3" STAINLESS	S-4948	FAK5445	KING PIN SET
S-C111	DCX006203	FLAT BAND CLAMP 4" ALUMINIZED	S-4948	FAK5446	KING PIN SET
S-B339	EC30PLS	3" PREFORMED CLAMP STAINLESS	S-4949	FAK5447	KING PIN SET
S-C110	EC35PLA	3.5" PREFORMED CLAMP ALUMINIZED	S-4949	FAK5448	KING PIN SET
S-4965	EC40EST	4" FLAT BAND CLAMP STAINLESS	S-5134	FAK5451	KING PIN SET
S-8476	EC40PLA	4" PREFORMED CLAMP ALUMINIZED	S-5223	FAK5452	KING PIN SET
S-C109	EC40PLB	4" PREFORMED BUTT TYPE CLAMP	S-4988	FAK5453	KING PIN SET
S-D424	EC40PLS	4" PREFORMED CLAMP STAINLESS	S-A483	FAK5455	KING PIN SET
S-4966	EC50EST	5" FLAT BAND CLAMP STAINLESS	S-A484	FAK5456	KING PIN SET
S-7687	EC50PLA	5" PREFORMED CLAMP ALUMINIZED	S-4756	FAK8492	SHIM
S-A999	EC50PLS	5" PREFORMED CLAMP STAINLESS	S-4603	FDL1034	DRAG LINK ASSEMBLY
S-8883	ETN0040635	MOTOR	S-A719	FDL1214A	DRAG LINK ASSEMBLY
S-5848	ETN0083799	NUT	S-C618	FDL1215A	DRAG LINK ASSEMBLY
S-C634	ETN0113743	SHIFT HOUSING ASSEMBLY-2 SPEED	S-4707	FDL970A	DRAG LINK ASSEMBLY
S-5691	ETN0113744	CIRCUIT BOARD ONLY	S-A828	FDL979	DRAG LINK
S-6058	ETN0113745	SHIFT MOTOR	S5FF5052	FF5052	AIR FILTER
S-A760	ETN0113753	HARNESS & CONNECTOR	S5FF5207	FF5207	AIR FILTER
S-5318	ETN0119855	SEAL	S-4601	FP3979	BEARING
S-A762	ETN0120750	SHIFT HOUSING ASSEMBLY-2 SPEED	S-5237	FP47678	BEARING
S-5582	ETN0122000	SHIFT KIT	S-5504	FP62052RS2	BEARING
S-8008	ETN0211319	CIRCUIT BOARD ASSY.	S-5940	FP63062RS2	BEARING
S-C464	ETN0328344	KING PIN SET	S-5940	FP63062Z	BEARING
S-C464	ETN0823078	KING PIN SET	S-6654	FP72487	BEARING
S-4996	FAK4446	KING PIN SET	S-5504	FPG88505	BEARING
S-5014	FAK4450	KING PIN SET	S-A312	FPHM212011	BEARING
S-5015	FAK4451	KING PIN SET	SSFS1000	FS1000	AIR FILTER
S-6493	FAK4461	KING PIN SET	SSFS1212	FS1212	AIR FILTER
S-6494	FAK4471	KING PIN SET	S-5056	FTR187L	TIE ROD END
S-5132	FAK4475	KING PIN SET	S-5057	FTR187R	TIE ROD END
S-6663	FAK4477	KING PIN SET	S-8634	FTR2069R	TIE ROD END
S-6499	FAK4478	KING PIN SET	S-8635	FTR2070L	TIE ROD END
S-6495	FAK4482	KING PIN SET	S-6659	FTR2090L	TIE ROD END L.H.
S-7463	FAK4485	KING PIN SET	S-5988	FTR2091R	TIE ROD END R.H.
S-4948	FAK4496	KING PIN SET	S-6659	FTR3033L	TIE ROD END L.H.

LATEST ADDITIONS TO OUR CATALOG

UNLESS OTHERWISE NOTED, ALL PARTS SUPPLIED ARE S & S/NEWSTAR. USE OF OTHER MANUFACTURERS' NAMES, PART NUMBERS, OR TRADEMARKS ARE FOR INFORMATIONAL AND IDENTIFICATION PURPOSES ONLY.



COMPLETE PARTS LISTING

NUMERICAL LISTING OF PART NUMBERS SUITABLE FOR INTERNATIONAL TRUCK

NEWSTAR NUMBER	REPLACEMENT FOR INTERNATIONAL TRUCK NUMBER	DESCRIPTION	NEWSTAR NUMBER	REPLACEMENT FOR INTERNATIONAL TRUCK NUMBER	DESCRIPTION
S-5988	FTR3034R	TIE ROD END R.H.	S-11201	SN4017A	TREADLE ASSEMBLY
S-E395	FTR3476	TIE ROD END	S-5237	ST2112	BEARING
S-E394	FTR3477	TIE ROD END	S-5504	ST518	BEARING
S-4767	FTR373L	TIE ROD END L.H.	S-5940	ST623	BEARING
S-4768	FTR373R	TIE ROD END R.H.	S-6652	ST679	BEARING
S-7459	FTR411L	TIE ROD END L.H.	S-A312	ST985	BEARING
S-7460	FTR411R	TIE ROD END R.H.	S-11183	TL962Y101	TURN SIGNAL SWITCH
S-7358	FTR423L	TIE ROD END	S-11182	TL963Y100	TURN SIGNAL SWITCH
S-7357	FTR423R	TIE ROD END L.H.	S-A312	TMHM212011	BEARING
S-5048	FTR431L	DRAG LINK END	SSWF2071	WF2071	AIR FILTER
S-5049	FTR431R	DRAG LINK END	SSWF2072	WF2072	AIR FILTER
S-A764	FTR8224	TIE ROD END	SSWF2074	WF2074	AIR FILTER
S-A765	FTR8225	TIE ROD END	SSWF2077	WF2077	AIR FILTER
S-D639	FTR8407	TIE ROD END	S-4293	WP181091	WATER PUMP
S-D640	FTR8408	TIE ROD END	S-E803	WP181366	WATER PUMP
S-B599	FTR8409	TIE ROD END	S-D967	XH4CC	CLAMP
S-B600	FTR8410	TIE ROD END	S-D967	XH89548K	CLAMP
S-8904	FUL14651	TW-1 VALVE	S-A862	XH89549K	CLAMP
S-3774	FUL15512	SPLITTER VALVE	S-14513	ZBH994205	FAN CLUTCH KIT
S-2022	FUL16743	REGULATOR VALVE	S-14030	ZBH994305	FAN CLUTCH KIT
S-4397	FUL16859	ACTUATOR VALVE	S-14676	ZBH994307	FAN CLUTCH KIT
S-3774	FUL19974	SPLITTER VALVE	S-4675	ZCP2500016	CLAMP
S-6603	FUL22254	NUT	S-7537	ZFS89533K	CLAMP
S-6604	FUL55506	HOSE ASSY 18"	S-1802	ZKC1206	UNIVERSAL JOINT
S-6605	FUL55507	HOSE ASSY 20"	S-2171	ZKC153	UNIVERSAL JOINT
S-6606	FUL55508	HOSE ASSY 30"	S-7024	ZKC155	UNIVERSAL JOINT
S-6607	FUL55509	HOSE ASSY 34"	S-2860	ZKC160	UNIVERSAL JOINT
S-6608	FUL55516	HOSE ASSY 22"	S-7026	ZKC170	UNIVERSAL JOINT
S-6609	FUL55518	HOSE ASSY 32"	S-7027	ZKC178	UNIVERSAL JOINT
S-6610	FUL55522	HOSE ASSY 28"	S-7029	ZKC188	UNIVERSAL JOINT
S-4400	FUL55524	HOSE ASSY 27"	S-1980	ZKC2101211X	CENTER BEARING
S-6611	FUL55525	HOSE ASSY 17"	S-7020	ZKC2103911X	CENTER BEARING
S-6612	FUL55526	HOSE ASSY 26"	S-7926	ZKC2106611X	CENTER SUPPORT
S-6613	FUL55527	HOSE ASSY 15"	S-7434	ZKC279	UNIVERSAL JOINT
S-3103	FULA3546	VALVE ASSY	S-7435	ZKC280	UNIVERSAL JOINT
S-3291	FULA3991	SLAVE VALVE ASSY.	S-2627	ZKC281	UNIVERSAL JOINT
S-6529	FULA4041	AIR FILTER ASSY.	S-6099	ZKC407	UNIVERSAL JOINT
S-8011	FULA4487	SELECTOR VALVE	S-13953	ZKC5308X	UNIVERSAL JOINT
S-8800	FULA4490	SELECTOR VALVE	S-C472	ZKC5674X	UNIVERSAL JOINT
S-5494	FULA4491	SELECTOR VALVE	S-C473	ZKC5675X	UNIVERSAL JOINT
S-3291	FULA4688	SLAVE VALVE ASSY.	S-C474	ZKC5676X	UNIVERSAL JOINT
S-9146	FULA4740	FILTER/REG. ASSY.	S-C475	ZKC5677X	UNIVERSAL JOINT
S-8030	FULA5000	SLAVE VALVE	S-6125	ZKC6100	UNIVERSAL JOINT
S-C462	FULA5010	RANGE VALVE	S-1720	ZKC7000	UNIVERSAL JOINT
S-C460	FULA5015	RANGE VALVE	S-6116	ZKC7202	UNIVERSAL JOINT
S-C462	FULA6909	RANGE VALVE	S-13211	ZKC785	UNIVERSAL JOINT
S-C461	FULA6913	RANGE VALVE	S-6123	ZKC8200	UNIVERSAL JOINT
S-C460	FULA6915	RANGE VALVE	S-6918	ZKC92	UNIVERSAL JOINT
S-5696	FULK1486	REPAIR KIT-FILTER	S-E129	ZKCSPL90	UNIVERSAL JOINT
S-5743	FULK1550	SEL.VALVE REPAIR KIT	S-E129	ZKCSPL90X	UNIVERSAL JOINT
S-4405	FULK1566	O-RING KIT	S-5676	ZZKN20001	TW-1 VALVE
S-9043	FULK1698	FILTER KIT	S-5677	ZZKN20025	PP-7 VALVE
S-3307	FULK1699	O-RING KIT	S-4898	ZZKN28060	VALVE
S-9404	FULK1826	REPAIR KIT	S-6085	ZZKN28500	RG-2 RELAY VALVE
S-9405	FULK1921	REPAIR KIT	S-8328	ZZKN32011	QR-1 VALVE
S-9406	FULK1922	REPAIR KIT			
S-9407	FULK1935	REPAIR KIT			
S-A210	FULK2170	FILTER REGULATOR KIT			
S-8336	FULK2424	SLAVE VALVE KIT			
S-D590	HF6162	FILTER CLEMENT			
S-7664	L17446	BELT			
S-9077	L17701	BELT, ALT. & FAN DRIVE			
SSLF3970	LF3970	AIR FILTER			
SSLF689	LF689	AIR FILTER			
SSLF9000	LF9000	AIR FILTER			
SSLF3620	LF3620	AIR FILTER			
S-E425	LP1047134	CLUTCH ASSEMBLY			
S-E426	LP1067144	CLUTCH ASSEMBLY			
S-E427	LP1072134	CLUTCH ASSEMBLY			
S-B230	R230104	TIE ROD END			
S-B231	R230105	TIE ROD END			



LATEST ADDITIONS TO OUR CATALOG

S & S WARRANTY

We warrant all new parts against defective material or workmanship when such parts are used in appropriate applications. We will NOT extend this warranty to parts where failure or damage was caused by misapplication, accident, or abuse.

Unless otherwise stated, authorization from your salesperson is required to initiate any return for warranty. If our examination shows the parts to be defective, we will replace such parts free of charge. This warranty extends solely to replacement of defective parts; we disclaim liability for labor and/or special or consequential damages of any nature.

If it is necessary to return any parts under this warranty, the buyer agrees to wait for settlement of his claim before any deductions are made in payments to S & S. Any expenses incurred without the consent of S & S will be disallowed.



Established in 1954, S & S Truck Parts, Inc. is one of the largest independent suppliers of replacement truck parts in the world. Traditionally known as a drive train gear specialist, S&S has aggressively expanded its product range.

Under the **NEWSTAR**™ label, S&S supplies many of the fastest-moving parts and components in the following categories: Powertrain, Transmission, Differential, Chassis, Drive Line, Hydraulic, PTO, Power Steering, Body Parts, HVAC and Air Brake Parts.



S & S Truck Parts, Inc.

USA

Corporate Headquarters
600 W. Irving Park Road
Schaumburg, Illinois 60193
Local Phone : 847-584-2000
Toll Free: 1-800-621-1553 Order Desk
Local Fax : 847-584-3000
Toll Free Fax : 1-800-621-1558
Mexico Toll Free :001-800-727-8373

5320 Departure Drive
Raleigh, NC 27616
Toll Free: 800-334-7058
Local Fax : 919-872-2836

5350 Ontario Mills Pkwy, Suite 200
Ontario, CA 91764
Toll Free: 888-621-1553
Local Fax : 909-481-8555

1401 Valley View Lane, Suite 135
Irving, Texas 75061
Toll Free: 855-621-1553
Local Fax: 972-986-9333

Canada

6460 Kestrel Road
Mississauga, Ontario
L5T 1Z7
Local Phone : 905-564-7100
Toll Free: 1-800-363-4148
Local Fax : 905-564-3485

19272 - 96th Ave. Unit #15
Surrey, British Columbia
V4N 4C1
Local Phone : 604-882-2577
Toll Free: 1-800-665-4327
Local Fax : 604-882-3898

176 Creditstone Road, Unit 10
Concord, Ontario
L4K 4H7
Local Phone : 905-761-1399
Toll Free: 1-800-363-4148
Local Fax : 905-761-0698

5318 Finch Ave. East Unit #1-4
Scarborough, Ontario
M1S 5G2
Local Phone : 416-412-7555
Local Fax : 416-412-7580

Visit our website at www.sandstruck.com

E-mail Address : info@sandstruck.com

AMERICAN EXPRESS, MASTERCARD AND VISA ACCEPTED

